

Vario-Series • Rectangular Indicator/Controllers

For Direct Current or Direct Voltage with 1 or 2 Limit Contacts



Moving-coil movement, edgewise scale
Narrow front frame per DIN 43 718, matt black



PFFN 96 x 24 M

Technical Data

Front Dimensions mm Type	96 x 24 PFFN 96 x 24 M	96 x 48 PFN 96 x 48 M	144 x 36 KODPR 144 F	144 x 72 KODPR 144 SE
Scale Length mm	65	65	96	98
Class	1.5	1.5	1.5	1.5
Weight approx. (kg)	0.2	0.5 (at U _H AC) 0.2 (at U _H DC)	0.6	1.1
Sampling	electronic	electronic	electronic	electronic
Relative Switching Speed (max. error as related to scale length)	1 %	1 %	1 %	1 %
Repetition Accuracy (at nom. aux. voltage and 23 °C)	0.1 %	0.1 %	0.1 %	0.1 %
Number of Limits	1 or 2	1 or 2	1 or 2	1 or 2
Min. Limit Separation (of scale length)	3 %	3 %	1.5 %	1.5 %
Output Relay	built in	built in	attachable on back	attachable on back
Output Contact	1 changeover per limit	1 changeover per limit	1 changeover per limit	1 changeover per limit
Switching Capacity with Restive Load				
Max. Switching Voltage	250 V AC / 250 V DC	250 V AC / 250 V DC	250 V AC / 250 V DC	250 V AC / 250 V DC
Max. Switching Current	6 A AC / 6 A DC	6 A AC / 6 A DC	3 A AC / 3 A DC	3 A AC / 3 A DC
Nominal Switching Capacity	500 VA / 50 W	500 VA / 50 W	750 VA / 50 W	750 VA / 50 W
Service Life at nominal Switching Capacity	> 10 ⁶ switching cycles	> 10 ⁶ switching cycles	> 10 ⁶ switching cycles	> 10 ⁶ switching cycles
Max. Switching Time	500 ms	500 ms	50 ms	50 ms
Auxiliary Voltage (U _H)	24 V DC (20...24...30 V) ¹⁾	24 V DC (20...24...30 V) o. 24 ... 240 V AC, 45...65 Hz	24 V DC (20...24...30 V) ¹⁾	24 V DC (20...24...30 V) ¹⁾
Power Consumption	4 VA / 4.5 W	4 VA / 4.5 W	5 VA / 4 W	5 VA / 4 W
Safety Class	CAT III	CAT III	CAT III	CAT III
Pollution Degree	2	2	2	2
Operating Voltage	300 V	300 V	150 V	150 V
Operating Voltage for Measuring Ranges > 250 V ... ≤ 600 V	300 V	600 V	150 V	150 V
Test Voltage	3.5 kV	5.8 kV	2.2 kV	2.2 kV
Front Housing-Panel Protection	IP 52	IP 52	IP 50	IP 50
Fasteners	screw spindle	screw spindle	screw spindle	screw spindle

¹⁾ With separate power supply for following voltages: 24 V AC, 115 V AC and 230 V AC, ± 10 %; see accessories, page 130

Description

Analog indicator/controller with moving-coil movement for direct current or direct voltage

Display

Scale Division Special Division
 Pointer Beam pointer with knife-edge for single and double Division

Mechanical Design

Housing Material Polycarbonate, self-extinguishing and drip-proof per UL 94 V-0
 Replaceable Glass windows and front frames
 ⇒ May only be replaced under
 voltage-free conditions!
 Terminals Tab connectors (IP20 protection) 1 x 6.3 x 0.8 mm,
 2 x 2.8 x 0.8 mm or 4.8 x 0.8 mm

Internal Resistance / Voltage Drop / Power Consumption

(Values only apply with zero point at let or at bottom)

Measuring Range	Internal Resistance / Voltage Drop / Power Consumption
≥ 100 μA / ≤ 10 mA	≤ 100 mV
> 10 mA / ≤ 6 A	≤ 100 mV
≥ 60 mV / ≤ 1 V	≥ 200 kΩ/V
> 1 V / ≤ 50 V	≥ 10 kΩ/V
> 50 V / ≤ 600 V	≥ 10 kΩ/V
0/4 ... 20 mA	6 Ω ¹⁾
Connection to Shunt	6 mA ²⁾

¹⁾ Tolerance ± 30%

²⁾ Tolerance ± 20%

Reference Conditions

Reference Quantities	Reference Conditions
Ambient Temperature	23 °C ± 2 °C
Position of Use	control panel vertical ± 1°
Other	DIN EN 60 051



Vario-Series • Rectangular Indicator/Controllers

For Direct Current or Direct Voltage with 1 or 2 Limit Contacts

General Issues

Indicator/controllers are meters with adjustable limits.
 The accuracy of the limits are not influenced by the contacts.
 Our meters and indicator/controllers comply with the regulations of the European Guidelines 73/23/EWG. This is proven by the compliance with the following standards:
 IEC 61010-1/A2 / EN 61010-1/A2 VDE 0411-1/A1 (Safety Regulations)
 IEC 60051/EN 60051/DIN EN 60051 (Meters with Scale Display)
 EN 50081-2: 1993 EMV (Emitted Interference, Industries)
 EN 50082-2: 1995 EMV (Emitted Interference, Industries)
 To protect the movable part of the indicator/controller against shocks, the bearings are spring mounted.

Application

Indicator/controllers display the actual value and energise with the help of one or more limits one or more relays. Their contacts can be used for monitoring, operating or controlling.
 Indicator/controllers are also available with logic output (transistor output).

Sampling

The sampling of the indicator/controllers works contact-free.
 When the pointer reaches the limit the switching operation will be disengaged.

Contacting

The max. contact disengages the switching operation when it overshoots the adjusted scale value. The min. contact disengages the switching operation when it undershoots the adjusted scale value.

Fasteners

Screw spindle
 (control panel thickness 1 ... 40 mm)

All indicator/controllers cause a permanent contact. This means that the output signal is held up as long as the pointer does not overrun the adjusted limit. The indicator/controllers are available as closed-circuit current model or working current model (see different Order No.).

Closed-Circuit Current Model: When the indicator/controller is not-operated, a voltage is impressed on the relays (output signal H, logic output). The voltage drops as soon as one of the contact marks is undershot or overshoot. The same happens when a power breakdown or an electronic breakdown occurs and no limit is overshoot or undershot (self supervision). A short-term power failure leads to the same effect.

Working Current Model: When the indicator/controller is not-operated the relays are in zero current condition (output signal L, logic output). As soon as one of the limits is overshoot or undershot the relays pick up (output signal H).

Position of Limits

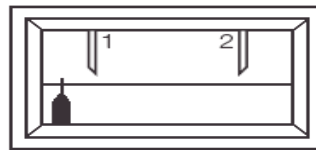

Contact Assignments

Measured Quantity	-	(1-) 12-	+ (2+) 11+
Auxiliary Voltage	DC	L - (12-)	L + (13+)
Relay Output	Logic Output		
Limit Contact 1	(1) 42	41 (2)	43 (3)
Limit Contact 2	(1) 52	51 (2)	53 (3)
The output contacts are shown in the wiring diagram in the zero current condition		+ terminals are electrically connected within the instrument	

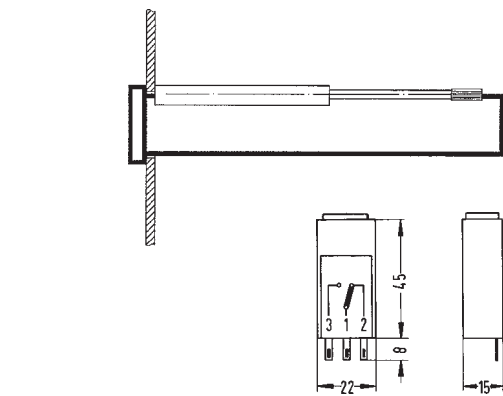

Basic Dimensions

Relay

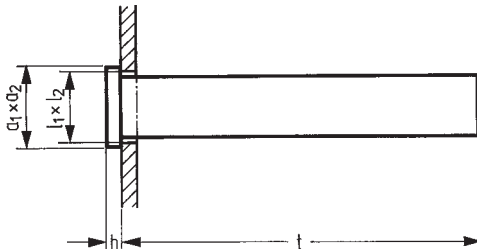

Ordering Example:

Indicator/Controller 96 x 24 mm for direct voltage, landscape scale,
 Measuring range 0 ... 100 V, direct connection, zero point at left,
 Working voltage-version with 2 limit contacts (Max. - Max.)

Techn. Data Type: PFFN 96 x 24 M	Order No. 2524P, AM11, DC100
--	--

Front Dim. mm	Nominal Dimensions		Cutout Dimensions l ₁ x l ₂	Installation Depth (t) Relay Output	Installation Depth (t) Logic Output
	a ₁ x a ₂	h			
96 x 24	96 x 24	5	92 ^{+0.8} x 22.2 ^{+0.3}	146	126
96 x 48	96 x 48	5	92 ^{+0.8} x 45 ^{+0.6}	146	126
144 x 36	144 x 36	8	137.5 ^{+0.8} x 32.5 ^{+0.6}	246	202
144 x 72	144 x 72	8	137.7 ^{+0.8} x 67.7 ^{+0.6}	248	205



Vario-Series • Rectangular Indicator/Controllers

For Direct Current or Direct Voltage with 1 or 2 Limit Contacts

Moving-coil movement, edgewise scale

Narrow front frame per DIN 43 718, matt black

'N' = Standard Version · 'A' = Extra Charge · '+' = Available without extra Charge · '-' = Not available

		Type	PFFN 96x24 M	PFFN 96x48 M	KODPR 144 F	KODPR 144 SE	
		Order No. ⇒	2524P	2594P	61102...	65102...	
		+ ↓			+ ↓	+ ↓	
Limits		HQ1	N	N	N	N	
		HQ2	+	+	+	+	
Closed-Circuit Current Model	Max.	AM3	+	+	+	+	
	Min.	AM4	+	+	+	+	
	Min. - Max.	AM5	A	A	A	A	
	Max. - Max.	AM6	A	A	A	A	
	Min. - Min.	AM7	A	A	A	A	
Working Current Model	Max.	AM8	+	+	+	+	
	Min.	AM9	+	+	+	+	
	Min. - Max.	AM10	A	A	A	A	
	Max. - Max.	AM11	A	A	A	A	
	Min. - Min.	AM12	A	A	A	A	
Zero Point - left / bottom							
Direct Current							
Range	0 ... 100 μ A	CA100	A	A	...34240	...34240	
	0 ... 150 μ A	CA150	A	A	...34270	...34270	
	0 ... 250 μ A	CA250	A	+	...34300	...34300	
	0 ... 400 μ A	CA400	A	+	...34320	...34320	
	0 ... 600 μ A	CA600	—	+	...34350	...34350	
	> 100 μ A ... < 1 mA ¹⁾	CA...	A	A	...31005	...31005	
	0 ... 1 mA	CB1	+	+	...35110	...35110	
	0 ... 1.5 mA	CB1.5	+	+	...35120	...35120	
	0 ... 2.5 mA	CB2.5	+	+	...35130	...35130	
	0 ... 4 mA	CB4	+	+	...35140	...35140	
	0 ... 5 mA	CB5	+	+	...35150	...35150	
	0 ... 6 mA	CB6	+	+	...35160	...35160	
	0 ... 10 mA	CB10	+	+	...35170	...35170	
	0 ... 15 mA	CB15	A	+	...35180	...35180	
	0 ... 20 mA	CB20	A	+	...35190	...35190	
	0 ... 25 mA	CB25	A	+	...35200	...35200	
	0 ... 40 mA	CB40	A	+	...35210	...35210	
	0 ... 50 mA	CB50	A	+	...35220	...35220	
	0 ... 60 mA	CB60	A	+	...35230	...35230	
	0 ... 100 mA	CB100	A	+	...35240	...35240	
	0 ... 150 mA	CB150	A	+	...35270	...35270	
	0 ... 250 mA	CB250	A	+	...35300	...35300	
	0 ... 400 mA	CB400	A	+	...35320	...35320	
	0 ... 600 mA	CB600	A	+	...35350	...35350	
	> 1 mA ... < 1A ¹⁾	CB...	A	A	...31005	...31005	
Electr. suppressed							
	4 ... 20 mA	landscape	BC25	A	A	...35199	...35199
	4 ... 20 mA	portrait	BC27	A	A	...35198	...35198
	0 ... 1 A		CC1	A	+	...36110	...36110
	0 ... 1.5 A		CC1.5	A	+	...36120	...36120
	0 ... 2.5 A		CC2.5	A	+	...36130	...36130
	0 ... 4 A		CC4	A	+	...36140	...36140
	0 ... 6 A		CC6	A	+	...36160	...36160
	> 1 A ... < 6 A ¹⁾		CC...	A	A	...31005	...31005

1) Specify in clear text

Vario-Series • Rectangular Indicator/Controllers

For Direct Current or Direct Voltage with 1 or 2 Limit Contacts

**Moving-coil movement, edgewise scale****Narrow front frame per DIN 43 718, matt black**

'N' = Standard Version · 'A' = Extra Charge · '+' = Available without extra Charge · '-' = Not available

		Type Order No. ⇒	PFFN 96x24 M 2524P	PFFN 96x48 M 2594P	KODPR 144 F 61102...	KODPR 144 SE 65102...
Limits	Landscape	+ ↓ HQ1	N	N	+ ↓	+ ↓
	Portrait	HQ2	+	+	+	+
Closed-Circuit Current Model	Max.	AM3	+	+	+	+
	Min.	AM4	+	+	+	+
	Min. - Max.	AM5	A	A	A	A
	Max. - Max.	AM6	A	A	A	A
	Min. - Min.	AM7	A	A	A	A
Working Current Model	Max.	AM8	+	+	+	+
	Min.	AM9	+	+	+	+
	Min. - Max.	AM10	A	A	A	A
	Max. - Max.	AM11	A	A	A	A
	Min. - Min.	AM12	A	A	A	A
Zero Point - left / bottom						
Connection to Shunt (Direct Current)						
	... A / 60 mV	BE3 ¹⁾	A	+	...32230	...32230
	... A / 150 mV	BE4 ¹⁾	A	+	...32270	...32270
	... A / ... > 60 mV ²⁾	BE981 ¹⁾	A	A	...31005	...31005
Scale:	1 A	CG1	+	+	+	+
	1.5 A	CG1.5	+	+	+	+
	2.5 A	CG2.5	+	+	+	+
	4 A	CG4	+	+	+	+
	5 A	CG5	+	+	+	+
	6 A	CG6	+	+	+	+
	10 A	CG10	+	+	+	+
	15 A	CG15	+	+	+	+
	20 A	CG20	+	+	+	+
	25 A	CG25	+	+	+	+
	30 A	CG30	+	+	+	+
	40 A	CG40	+	+	+	+
	50 A	CG50	+	+	+	+
	60 A	CG60	+	+	+	+
	75 A	CG75	+	+	+	+
	100 A	CG100	+	+	+	+
	150 A	CG150	+	+	+	+
	200 A	CG200	+	+	+	+
	250 A	CG250	+	+	+	+
	300 A	CG300	+	+	+	+
	400 A	CG400	+	+	+	+
	500 A	CG350	+	+	+	+
	600 A	CG600	+	+	+	+
0 ... > 1 A ... < 1 kA ²⁾	CG...	+	+	+	+	
	1 kA	CH1	+	+	+	+
	1.5 kA	CH1.5	+	+	+	+
	2.5 kA	CH2.5	+	+	+	+
	4 kA	CH4	+	+	+	+
	5 kA	CH5	+	+	+	+
	6 kA	CH6	+	+	+	+
	10 kA	CH10	+	+	+	+
	15 kA	CH15	+	+	+	+
	> 1 kA ²⁾	CH...	+	+	+	+

1) Complement with CG... or CH...

2) Specify in clear text



Vario-Series • Rectangular Indicator/Controllers

For Direct Current or Direct Voltage with 1 or 2 Limit Contacts

Moving-coil movement, edgewise scale

Narrow front frame per DIN 43 718, matt black

'N' = Standard Version · 'A' = Extra Charge · '+' = Available without extra Charge · '-' = Not available

		Type	PFFN 96x24 M	PFFN 96x48 M	KODPR 144 F	KODPR 144 SE
		Order No. ⇒	2524P	2594P	61102...	65102...
		+ ↓			+ ↓	+ ↓
Limits		HQ1	N	N	N	N
		HQ2	+	+	+	+
Closed-Circuit Current Model	Max.	AM3	+	+	+	+
	Min.	AM4	+	+	+	+
	Min. - Max.	AM5	A	A	A	A
	Max. - Max.	AM6	A	A	A	A
	Min. - Min.	AM7	A	A	A	A
Working Current Model	Max.	AM8	+	+	+	+
	Min.	AM9	+	+	+	+
	Min. - Max.	AM10	A	A	A	A
	Max. - Max.	AM11	A	A	A	A
	Min. - Min.	AM12	A	A	A	A
Zero Point - left / bottom						
Direct Voltage						
Range						
0 ... 60 mV		DB60	A	A	...31230	...31230
0 ... 100 mV		DB100	A	A	...31240	...31240
0 ... 150 mV		DB150	A	A	...31270	...31270
0 ... 250 mV		DB250	A	+	...31300	...31300
0 ... 400 mV		DB400	A	+	...31320	...31320
0 ... 600 mV		DB600	A	+	...31350	...31350
0 ... > 60 mV... < 1 V ¹⁾		DB...	A	A	...31005	...31005
0 ... 1 V		DC1	A	+	...33110	...33110
0 ... 1.5 V		DC1.5	A	+	...33120	...33120
0 ... 2.5 V		DC2.5	A	+	...33130	...33130
0 ... 4 V		DC4	A	+	...33140	...33140
0 ... 5 V		DC5	A	+	...33150	...33150
0 ... 6 V		DC6	A	+	...33160	...33160
0 ... 10 V		DC10	A	+	...33170	...33170
0 ... 15 V		DC15	A	+	...33180	...33180
0 ... 20 V		DC20	A	+	...33190	...33190
0 ... 25 V		DC25	A	+	...33200	...33200
0 ... 40 V		DC40	A	+	...33210	...33210
0 ... 50 V		DC50	A	+	...33220	...33220
0 ... 60 V		DC60	A	+	...33230	...33230
0 ... 100 V		DC100	A	+	...33240	...33240
0 ... 150 V		DC150	A	+	...33270	...33270
0 ... 250 V		DC250	A	+	...33300	...33300
0 ... 400 V		DC400	A	+	...33320	...33320
0 ... 500 V		DC500	A	+	...33340	...33340
0 ... 600 V		DC600	A	+	...33350	...33350
0 ... > 1 V ... < 600 V ¹⁾		DC...	A	A	...31005	...31005
Measuring Inputs						
for thermocouple J, K, S ... / Pt100						
Ranges and versions on request						

1) Specify in clear text



Vario-Series • Rectangular Indicator/Controllers

For Direct Current or Direct Voltage with 1 or 2 Limit Contacts

Moving-coil movement, edgewise scale

Narrow front frame per DIN 43 718, matt black

Please note when ordering:

Only one Identification No. with the same letter sequence may be chosen. Order No. with Identification No. N (standard model) can be left out.

'N' = Standard Version · 'A' = Extra Charge · '+' = Available without extra Charge · '-' = Not available

	Type Order No. ⇒	PFFN 96x24 M 2524P	PFFN 96x48 M 2594P	KODPR 144 F 61102...	KODPR 144 SE 65102...
	+ ↓ HQ1 HQ2	N +	N +	N +	N +
GENERAL VARIANTS					
Zero Point					
Zero point at left (landscape)	BC1	N	N	N	N
Zero point at bottom (portrait)	BC4	+	+	+	+
Zero point at center	BC2	A	A	A	A
Zero point between bottom and center of scale ¹⁾	BC21	A	A	A	A
Position of Use					
Control panel vertical	LA1	N	N	N	N
Control panel horizontal	LA2	+	+	+	+
Other	LA999	A	A	A	A
(Please specify angle between scale and horizontal)					
OUTPUT VARIANTS					
Relay output	AU1	N	N	N	N
Logic output (open collector)	AU2	+	+	+	+
H = + 24 V (electrically isolated from U _H) L < + 1 V, I ≤ 50 mA (20 mA at U _H AC)					
AUXILIARY VOLTAGE VARIANTS					
24 V DC (20...24...30 V)	IV22	N	N	N	N
24 V AC (21...24...27 V) 45...65 Hz	IV12	A ²⁾	+	—	—
100 V AC (90...100...110 V) 45...65 Hz	IV10	—	+	—	—
110 V AC (99...110...121 V) 45...65 Hz	IV13	—	+	—	—
115 V AC (103...115...127 V) 45...65 Hz	IV16	A ²⁾	+	+	+
220 V AC (198...220...242 V) 45...65 Hz	IV19	—	+	—	—
230 V AC (207...230...253 V) 45...65 Hz	IV23	A ²⁾	+	+	+
240 V AC (216...240...264 V) 45...65 Hz	IV24	—	+	—	—
SCALE VARIANTS					
Division and Pointer					
Single division	GD1	N	N	N	N
Double division ¹⁾	GD2	A	A	A	A
Additional Imprint					
Second numbering, black ¹⁾	SK982	A	A	A	A
Second numbering, red (RAL 2002) ¹⁾	SK983	A	A	A	A
Inscription:					
Without additional inscription	SM99	N	N	N	N
Inscription ≤ 15 characters German ¹⁾	SM991	A	A	A	A
Inscription ≤ 15 characters other language ¹⁾ (Latin lettering)	SM993	A	A	A	A
Coloured mark red RAL 2002	ST981	A	A	A	A
Coloured sector red (RAL 2002) ¹⁾	SU981	A	A	A	A
Coloured sector green (RAL 6018) ¹⁾	SU982	A	A	A	A
HOUSING VARIANTS					
Application					
Standard version	LB99	N	N	N	N
Tropic resistant	LB1	A	A	—	—
Protection					
Standard (see technical data)	LH99	N	N	N	N
Housing panel IP 54, connections IP 20	LH22	A	A	—	—
Front Frame Colour					
Matt black	MA2	N	N	N	N
Matt grey RAL 7037	MA11	A	A	A	A
Glass Window					
Standard version	MG99	N	N	N	N
Anti-glare glass	MG1	A	A	A	A
Identification					
Without Identification	MZ99	N	N	N	N
Identification on the back ¹⁾	MZ998	A	A	A	A

¹⁾ Specify in clear text

²⁾ With external power supply unit (extra charge) for the following voltages: 24 V AC, 115 V AC and 230 V AC, ± 10 %; see accessories, page 130



Vario-Series • Rectangular Indicator/Controllers

For Direct Current or Direct Voltage with 4 Limit Contacts

Moving-coil movement, edgewise scale
Narrow front frame per DIN 43 718, matt black

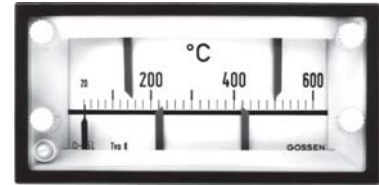

PFN 96 x 48 M

Technical Data

Front Dimensions mm Type	96 x 48 PFN 96 x 48 M
Scale Length mm	65
Class	1.5
Weight approx. (kg)	0.5
for auxiliary voltage 20 ... 40 V AC / DC	0.2
Sampling	electronic
Relative Switching Speed (max. error as related to scale length)	1 %
Repetition Accuracy (at nom. aux. voltage and 23 °C)	0.1 %
Number of Limits	4
Min. Contact Limit Clearance (of scale length)	3 %
Output Relay	built in
Output Contact	1 changeover per limit
Switching Capacity with Ohmic Load	
Max. Switching Voltage	300 V AC / DC
Max. Switching Current	6 A AC/DC
Nominal Switching Capacity	≤ 1500 VA
Service Life at Nominal Switching Capacity	> 10 ⁶ switching cycles
Max. Switching Time	500 ms
Auxiliary Voltage (U _H)	see order information
Power Consumption, AC Aux. Voltage	4 VA
Power Consumption, DC Aux. Voltage	4.5 W
Safety Regulations per IEC/EN 61010-1/A2 VDE 0411-1/A1	
Safety Class	II (total insulation)
Measuring Circuit:	
Over voltage Category	CAT III
Pollution Degree	2
Operating Voltage	300 V
Operating Voltage for Voltage Measuring > 250 V ... ≤ 600 V	600 V
Test Voltage (to Housing)	5.8 kV
Front Panel-Housing Protection	IP 52
Fasteners	screw spindle

Description

Analog indicator/controller with moving-coil movement for direct current or direct voltage

Display

Scale Division Coarse-fine
 Pointer Beam pointer with knife-edge for single and double division

Mechanical Design

Housing Material Polycarbonate, self-extinguishing and drip-proof per UL 94 V-0
 Replaceable Glass windows and front frames
 ⇒ May only be replaced under
 voltage-free conditions!
 Terminals tab connectors (IP 20 protection)
 1x 6.3 x 0.8 mm or 2 x 2.8 x 0.8 mm

Internal Resistance / Voltage Drop / Power Consumption

(Values only apply with zero point at left or at bottom)

Measuring Range	Internal Resistance / Voltage Drop / Power Consumption
≥ 100 μA / ≤ 10 mA	≤ 100 mV
> 10 mA / ≤ 6 A	≤ 100 mV
≥ 60 mV / ≤ 1 V	≥ 1 MΩ
> 1 V / ≤ 50 V	≥ 100 kΩ
> 50 V / ≤ 600 V	≥ 2 kΩ / V
0/4 ... 20 mA	6 Ω ¹⁾
Connection to shunt	6 mA ²⁾

1) Tolerance ±30 %

2) Tolerance ±20 %

Reference Conditions

Reference Quantities	Reference Conditions
Ambient Temperature	23 °C ± 2 °C
Position of Use	control panel vertical ± 1 °
Other	DIN EN 60 051

Ordering Example:

Indicator/Controller 96 x 48 mm for direct voltage, landscape scale,
 Measuring range 0 ... 100 V, direct voltage,
 Closed-circuit current model, contacting Min.-Max. /Min.-Max.

Techn. Data Type: PFN 96 x 48 M	Order No. 2596P, AM40, DC100
------------------------------------	---------------------------------

Vario-Series • Rectangular Indicator/Controllers

For Direct Current or Direct Voltage with 4 Limit Contacts



General Issues

Indicator/controllers are meters with adjustable limits.
 The accuracy of the limits are not influenced by the contacts.
 Our meters and indicator/controllers comply with the regulations of the European Guidelines 73/23/EWG. This is proven by the compliance with the following standards:
 IEC 61010-1/A2 / EN 61010-1/A2 VDE 0411-1/A1 (Safety Regulations)
 IEC 60051/EN 60051/DIN EN 60051 (Meters with Scale Display)
 EN 50081-2: 1993 EMV (Emitted Interference, Industries)
 EN 50082-2: 1995 EMV (Emitted Interference, Industries)
 To protect the movable part of the indicator/controller against shocks, the bearings are spring mounted.

Application

Indicator/controllers display the actual value and energise with the help of one or more limits one or more relays. Their contacts can be used for monitoring, operating or controlling.
 Indicator/controllers are also available with logic output (transistor output).

Sampling

The sampling of the indicator/controllers works contact-free.
 When the pointer reaches the limit the switching operation will be disengaged.

Contacting

The max. contact disengages the switching operation when it overshoots the adjusted scale value. The min. contact disengages the switching operation when it undershoots the adjusted scale value.

Position of Limits

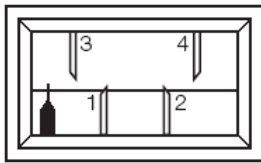

Fasteners

Screw spindle
 (control panel thickness 1 ... 40 mm)

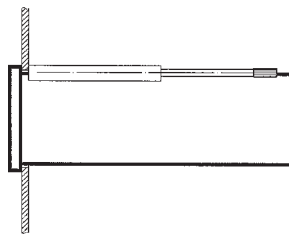

Basic Dimensions

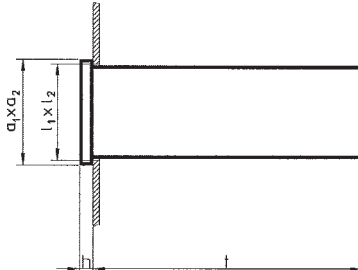

All indicators/controllers cause a permanent contact. This means that the output signal is held up as long as the pointer does not overrun the adjusted limit. The indicators/controllers are available as closed-circuit current model or working current model (see different Order No.).

Closed-Circuit Current Model: When the indicator/controller is not-operated a voltage is impressed on the relays (output signal H, logic output). The voltage drops as soon as one of the contact marks is undershot or overshoot. The same happens when a power breakdown or an electronic breakdown occurs and no limit is overshoot or undershot (self supervision). A short-term power failure leads to the same effect.

Working Current Model: When the indicator/controller is not-operated the relays are in zero current condition (output signal L, logic output). As soon as one of the limits is overshoot or undershot the relays pick up (output signal H).

Contact Assignments

Measuring Input	-	12-
	+	11+
Auxiliary Voltage	20 ... 40 VAC/DC	L1 L2
	90 ... 127 VAC	L
	198 ... 264 VAC	N
Relay Output	Logic Output	
Limit Contact 1		
Limit Contact 2		
Limit Contact 3		
Limit Contact 4		
The output contacts are shown in the wiring diagram in the zero current condition		+ terminals are electrically connected within the instrument

Front Dim. mm	Nominal Dimensions		Cutout Dimensions $l_1 \times l_2$	Installation Depth (t) Relay Output	Installation Depth (t) Logic Output
	$a_1 \times a_2$	h			
96 x 48	96 x 48	5	$92^{+0.8} \times 45^{+0.6}$	146	126



Vario-Series • Rectangular Indicator/Controllers

For Direct Current or Direct Voltage with 4 Limit Contacts

Moving-coil movement, edgewise scale

Narrow front frame per DIN 43 718, matt black

'N' = Standard Version · 'A' = Extra Charge · '+' = Available without extra Charge · '-' = Not available

	Type	PFN 96 x 48 M
	Order No. ⇒	2596P
	+ ↓	
Landscape	HQ1	N
Portrait	HQ2	+
Contacting ¹⁾		
Min. - Max. / Min. - Max. closed current	AM40	+
Min. - Max. / Max. - Max. closed current	AM41	+
Min. - Max. / Min. - Min. closed current	AM42	+
Min. - Min. / Min. - Min. closed current and		
Max. - Max. / Max. - Max. working current	AM43	+
Max. - Max. / Max. - Max. closed current and		
Min. - Min. / Min. - Min. working current	AM44	+
Min. - Max. / Min. - Max. working current	AM45	+
Min. - Max. / Max. - Max. working current	AM46	+
Min. - Max. / Min. - Min. working current	AM47	+
Zero Pint - left / bottom		
Direct Current		
Range		
0 ... 100 μ A	CA100	A
0 ... 150 μ A	CA150	A
0 ... 250 μ A	CA250	A
0 ... 400 μ A	CA400	A
0 ... 600 μ A	CA600	A
> 100 μ A ... < 1 mA ²⁾	CA...	A
0 ... 1 mA	CB1	+
0 ... 1.5 mA	CB1.5	+
0 ... 2.5 mA	CB2.5	+
0 ... 4 mA	CB4	+
0 ... 5 mA	CB5	+
0 ... 6 mA	CB6	+
0 ... 10 mA	CB10	+
0 ... 15 mA	CB15	A
0 ... 20 mA	CB20	A
0 ... 25 mA	CB25	A
0 ... 40 mA	CB40	A
0 ... 50 mA	CB50	A
0 ... 60 mA	CB60	A
0 ... 100 mA	CB100	A
0 ... 150 mA	CB150	A
0 ... 250 mA	CB250	A
0 ... 400 mA	CB400	A
0 ... 600 mA	CB600	A
> 1 mA ... < 1A ²⁾	CB...	A
Electr. suppressed		
0/4 ... 20 mA landscape	BC25	A
0/4 ... 20 mA portrait	BC27	A
0 ... 1 A	CC1	A
0 ... 1.5 A	CC1.5	A
0 ... 2.5 A	CC2.5	A
0 ... 4 A	CC4	A
0 ... 6 A	CC6	A
> 1 A ... < 6 A ²⁾	CC...	A

1) Number of contacts - specify in clear text

2) Specify in clear text



Vario-Series • Rectangular Indicator/Controllers

For Direct Current or Direct Voltage with 4 Limit Contacts

Moving-coil movement, edgewise scale

Narrow front frame per DIN 43 718, matt black

'N' = Standard Version · 'A' = Extra Charge · '+' = Available without extra Charge · '-' = Not available

		Type Order No. ⇒	PFN 96 x 48 M 2596P
	Landscape	+ ↓ HQ1	N
	Portrait	HQ2	+
Limits ¹⁾			
Min. - Max. / Min. - Max. closed current		AM40	+
Min. - Max. / Max. - Max. closed current		AM41	+
Min. - Max. / Min. - Min. closed current		AM42	+
Min. - Min. / Min. - Min. closed current and			
Max. - Max. / Max. - Max. working current		AM43	+
Max. - Max. / Max. - Max. closed current and			
Min. - Min. / Min. - Min. working current		AM44	+
Min. - Max. / Min. - Max. working current		AM45	+
Min. - Max. / Max. - Max. working current		AM46	+
Min. - Max. / Min. - Min. working current		AM47	+
Zero Point - left / bottom			
Connection to Shunt (Direct Current)			
... A / 60 mV		BE3 ²⁾	A
... A / 150 mV		BE4 ²⁾	A
... A / ... > 60 mV ³⁾		BE981 ²⁾	A
Scale:	1 A	CG1	+
	1.5 A	CG1.5	+
	2.5 A	CG2.5	+
	4 A	CG4	+
	5 A	CG5	+
	6 A	CG6	+
	10 A	CG10	+
	15 A	CG15	+
	20 A	CG20	+
	25 A	CG25	+
	30 A	CG30	+
	40 A	CG40	+
	50 A	CG50	+
	60 A	CG60	+
	75 A	CG75	+
	100 A	CG100	+
	150 A	CG150	+
	200 A	CG200	+
	250 A	CG250	+
	300 A	CG300	+
	400 A	CG400	+
	500 A	CG350	+
	600 A	CG600	+
	0 ... > 1 A ... < 1 kA ³⁾	CG...	+
	1 kA	CH1	+
	1.5 kA	CH1.5	+
	2.5 kA	CH2.5	+
	4 kA	CH4	+
	5 kA	CH5	+
	6 kA	CH6	+
	10 kA	CH10	+
	15 kA	CH15	+
	> 1 kA ³⁾	CH...	+

1) Number of limits - specify in clear text

2) Complement with CG... or CH...

3) Specify in clear text



Vario-Series • Rectangular Indicator/Controllers

For Direct Current or Direct Voltage with 4 Limit Contacts

Moving-coil movement, edgewise scale

Narrow front frame per DIN 43 718, matt black

'N' = Standard Version · 'A' = Extra Charge · '+' = Available without extra Charge · '-' = Not available

	Type Order No. ⇒	PFN 96 x 48 M 2596P
	+ ↓	
Landscape	HQ1	N
Portrait	HQ2	+
Limits ¹⁾		
Min. - Max. / Min. - Max. closed current	AM40	+
Min. - Max. / Max. - Max. closed current	AM41	+
Min. - Max. / Min. - Min. closed current	AM42	+
Min. - Min. / Min. - Min. closed current and		
Max. - Max. / Max. - Max. working current	AM43	+
Max. - Max. / Max. - Max. closed current and		
Min. - Min. / Min. - Min. working current	AM44	+
Min. - Max. / Min. - Max. working current	AM45	+
Min. - Max. / Max. - Max. working current	AM46	+
Min. - Max. / Min. - Min. working current	AM47	+
Zero Point - left / bottom		
Direct Voltage		
Range		
0 ... 60 mV	DB60	A
0 ... 100 mV	DB100	A
0 ... 150 mV	DB150	A
0 ... 250 mV	DB250	A
0 ... 400 mV	DB400	A
0 ... 600 mV	DB600	A
0 ... > 60 mV ... < 1 V ²⁾	DB...	A
0 ... 1 V	DC1	A
0 ... 1.5 V	DC1.5	A
0 ... 2.5 V	DC2.5	A
0 ... 4 V	DC4	A
0 ... 5 V	DC5	A
0 ... 6 V	DC6	A
0 ... 10 V	DC10	A
0 ... 15 V	DC15	A
0 ... 20 V	DC20	A
0 ... 25 V	DC25	A
0 ... 40 V	DC40	A
0 ... 50 V	DC50	A
0 ... 60 V	DC60	A
0 ... 100 V	DC100	A
0 ... 150 V	DC150	A
0 ... 250 V	DC250	A
0 ... 400 V	DC400	A
0 ... 500 V	DC500	A
0 ... 600 V	DC600	A
0 ... > 1 V ... < 600 V ²⁾	DC...	A
Measuring Inputs		
for thermocouple J, K, S ... / Pt100		
Ranges and versions on request		

1) Number of limits - specify in clear text

2) Specify in clear text



Vario-Series • Rectangular Indicator/Controllers

For Direct Current or Direct Voltage with 4 Limit Contacts

Moving-coil movement, edgewise scale

Narrow front frame per DIN 43 718, matt black

Please note when ordering:

Only one Identification No. with the same letter sequence may be chosen. Order No. with Identification No. N (standard model) can be left out.

'N' = Standard Version · 'A' = Extra Charge · '+' = Available without extra Charge · '-' = Not available

	Type Order No. ⇒	PFN 96 x 48 M 2596P
	+ ↓ HQ1	N
Landscape	HQ2	+
Portrait		
GENERAL VARIANTS		
Zero Point		
Zero point at left (landscape)	BC1	N
Zero point at bottom (portrait)	BC4	+
Zero point at the center	BC2	A
Zero point between bottom and center of scale ¹⁾	BC21	A
Position of Use		
Control panel vertical	LA1	N
Control panel horizontal	LA2	+
Other	LA999	A
(Please specify angle between scale and horizontal)		
OUTPUT VARIANTS		
Relay output	AU1	N
Logic output (open collector)	AU2	+
H = + 24 V (electrically isolated from U _h)		
L < + 1 V, I ≤ 25 mA at U _h 20 ... 40 V DC/AC		
I ≤ 10 mA at U _h 90 ... 127 V AC u+ and U _h 198 ... 267 V AC		
AUXILIARY VOLTAGE VARIANTS		
20...40 V DC / AC, 45...65 Hz	IV62	N
90...127 V AC, 45...65 Hz	IV60	A
198...267 V AC, 45...65 Hz	IV61	A
SCALE VARIANTS		
Division and Pointer		
Single division	GD1	N
Double division ¹⁾	GD2	A
Additional Imprint		
Second numbering, black ¹⁾	SK982	A
Second numbering, red (RAL 2002) ¹⁾	SK983	A
Inscription		
Without additional inscription	SM99	N
Inscription ≤ 15 characters German ¹⁾	SM991	A
Inscription ≤ 15 characters other language ¹⁾ (Latin lettering)	SM993	A
Coloured mark red RAL 2002 ¹⁾	ST981	A
Coloured sector red (RAL 2002) ¹⁾	SU981	A
Coloured sector green (RAL 6018) ¹⁾	SU982	A
HOUSING VARIANTS		
Application		
Standard version	LB99	N
Tropic resistant	LB1	A
Protection		
Standard (see technical data)	LH99	N
Housing panel IP 54, connections IP 20	LH22	A
Front Frame Colour		
Matt black	MA2	N
Matt grey, RAL 7037	MA11	A
Glass Window		
Standard version	MG99	N
Anti-glare glass	MG1	A
Identification		
Without identification	MZ99	N
Identification on the back ¹⁾	MZ998	A

¹⁾ Specify in clear text