

# MultiLog SRD-99

- ▣ data recorder
- ▣ up to 8 inputs 0/4 - 20 mA or Pt100/Pt500/Pt1000
- ▣ 2 electronic relay outputs (optoMOS)
- ▣ USB Host port for flash data storage
- ▣ RS-485 / Modbus RTU
- ▣ free configuration and recording software



The **MultiLog SRD-99** device is designed to record and display current values as well as to present technological parameters in the form of graphs. The device is equipped with eight temperature (Pt100/500/1000) or current (in the 0/4-20 mA standard) inputs, one pulse (digital) input for controlling the recording process and one USB Host port for flash data storage. Internal memory has 2 MB capacity (0.5 million data recordings altogether) or 8 MB in version with USB port (2 millions data recordings). However when a USB flash drive is plugged permanently, it can significantly extend the recording time without a need of data transferring from **SRD-99** to a PC. For example: 1GB flash drive allows continuous data recording for over 1 year (8 channels recorded every 1 sec., approx 250 millions data recordings)! Individual alphanumeric description (text) of each of the recorded channels is possible. The multi-language menu assisted with full text descriptions makes the unit configuration process quite easy. However, due to a significant number of configured parameters it is advised to use the attached configuration software for PCs.

New in **SRD-99** are 2 outputs - electronic relays with max. load 24V AC (35V DC) 200 mA. Main function of outputs is a signalisation of critical situations, but thanks to expanded menu it is possible to use it in numerous control and regulation applications. Both outputs can be driven by single measurement channel or by group of channels (from 1 to 8 channels) with individually adjustable thresholds for every measurement channel. Signalisation of output state is made as two fields described R1 and R2 in left upper corner of LCD screen.

- USB Host port for flash data storage and configuration transfer (option),
- a legible graphic display 128x64 points, with a backlight,
- current graph of trends for each channel separately,
- free configuration and recording software,
- insulated communication interface RS-485.

## Ordering

SRD-99-XX28-1-X-XX1

number of inputs:

1  
4  
8

type of inputs:

1 : current 0/4-20 mA  
3 : RTD (Pt100, Pt500, Pt1000)

options:

00 : no options  
01 : IP 65 frame (version without USB)  
0B : USB Host port provided with a protective cap  
0J : portable case P130 (front USB Host, no alarm connectors)

power supply:

3 : 24V AC/DC  
4 : 85V - 260V AC/DC

## An example of what the display looks like

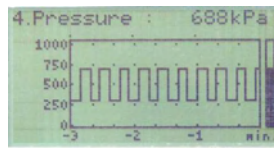

The history of the process in time

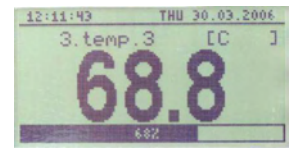

The current value of the measurement signal  
Height of the digits: 18 mm

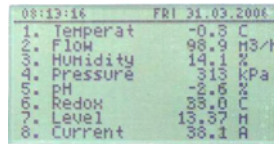

8-channel view displayed at the same time

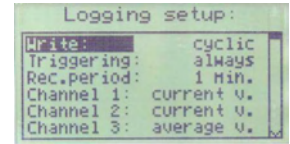

Logging parameters

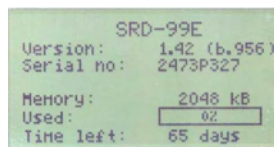

Device information

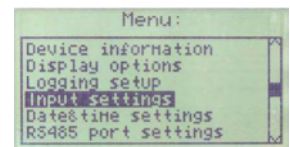

Main menu of the unit

## Technical data

**Power supply:** 19V ÷ 50V DC; 16V ÷ 35V AC or 85 ÷ 260V AC/DC, all separated

**Power consumption:** typical 7 VA; max. 12 VA

**Display:** graphic LCD, 128 x 64 points, with backlight

**Measuring inputs:** 1, 4 or 8; Pt100; Pt500; Pt1000 (2 and 3-conductor connection) or 0/4-20 mA inputs; common ground

**Measuring range:** ± 9999 ÷ decimal point (current inputs); -100°C ÷ +600°C (RTD inputs) with resolution 0,1°C

**Digital input:** 1 input 24V DC, optocoupled

**Outputs:** 2 electronic relays (ER1, ER2) with max. load 24V AC (35V DC) / 200 mA  
**Sensors supply (only current version):** 24 V DC ± 5%, max. 200 mA, not separated from measuring inputs

**Communication interface:** RS-485 (Modbus RTU) or USB Host port, galvanically separated

**Transmission speed:** 1200 - 115200 bit/sec.

**Internal memory capacity:** 2 MB (0.5 million data recordings) in version without USB, 8 MB (above 2 millions data recordings) in version with USB Host port

**Type of protection:**

**version without USB:** IP 65 (front), available options: additional frame IP 65

for panel cut-out sealing, transparent door STD-99, see: accessories

**version with USB:** a) IP 40, b) IP 54 (when fitted with STD-99 transparent door, see: accessories)

**Working temperature:** 0°C ÷ +50°C

**Storage temperature:** -10°C ÷ +70°C

**Case:** board

**Case material:** NORYL - GFN2S E1

**Case dimensions:** 96 x 96 x 100 mm

**Panel cut-out dimensions:** 90,5 x 90,5 mm

**Installation depth:** min. 102 mm

**Board thickness:** max. 5 mm

Software attached with data recorder

1. Loggy Soft

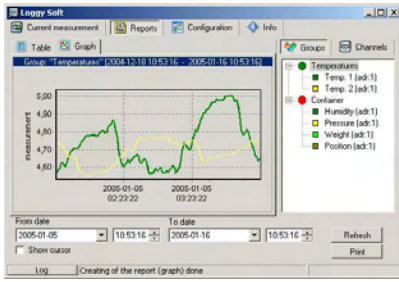

The **Loggy Soft** program enables the visualization, archiving and printing of measurements (e.g. temperature, humidity, pressure) stored in SRD-99-type device memory. Work with SRD-99-type devices takes place through an RS-485 serial interface or flash-disk devices plugged into USB port. Connecting a network of units to a serial port (RS-232) or USB port of a PC is possible thanks to a converter (RS-485 to RS-232 or RS-485 to USB) produced by SIMEX.

2. S-Toolkit

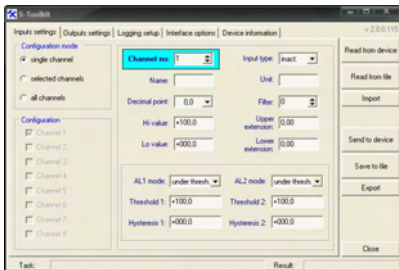

The **S-Toolkit** software enables configuration reading and writing operations, updating the device firmware and obtaining basic information on SRD-99-type devices through RS-485 serial interface or flash-disk devices plugged into USB port. This application enables to quickly and easily define device parameters in one of three possible configuration models. The set of parameters can be transmitted directly to the device or stored in a file for future use.

Content of package

- data recorder **SRD-99**,
- assembly brackets - 2 pieces,
- user's manual for **SRD-99** unit and for softwares: **Loggy Soft** and **S-Toolkit**,
- CD-ROM with the aforesaid manuals in PDF format and installations of **Loggy Soft** and **S-Toolkit** software (available optional with extra charge).



Extended network applications

We have extended our offer by ethernet applications and just there is no need to place PC with RS-485/USB converter near the installation. Now it can be installed on any location where internet is available. Additionally, we have expanded network functionality of SimCorder application. Now, it allows to upgrade your acquisition system of network functions based on TCP/IP protocol. This version consists of server, which collects measurement data from network and records them to database and clients which communicate to the server and allow watching stored data.

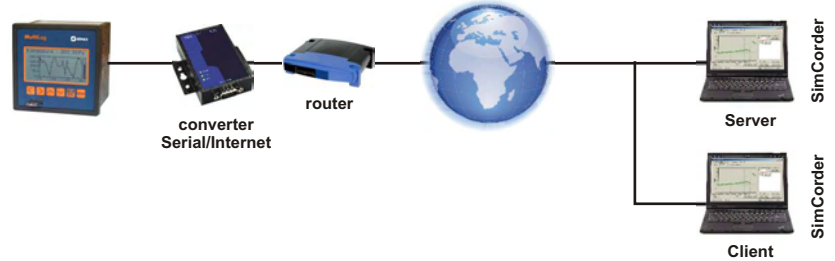

Exemplary pin assignment

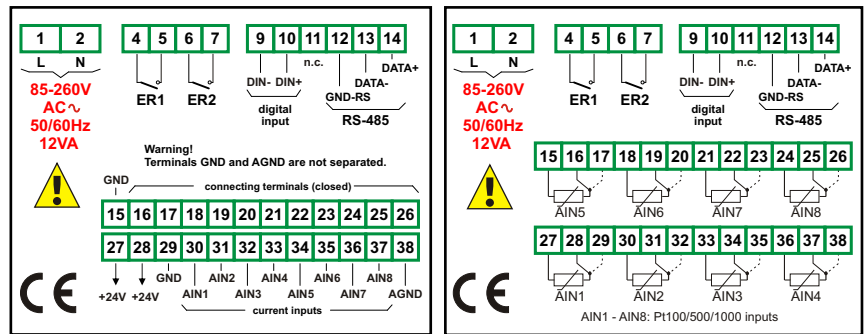

version with current inputs

version with Pt inputs

Accessories

**Portable case P130**  
(front USB Host, no alarm connectors)



**Converters:**

**SRS-U/4-Z45**  
converter USB/RS-485



**SRS-2/4-Z45**  
converter RS-232/RS-485



**STD-99**

Transparent door with moulded frame acc. to DIN 43700, lockable with security key. Door and frame are made by injection moulding thus assuring an exact fit, an optimal choice of a material which is very strong and with no risk of corrosion; perfect seal-protective system IP 54 acc. to DIN 40050 provided by all-round soft rubber sealing the moulding; due to the special door mountings, the door does not swing in or out sideways on opening; door-frame and front-frame can be exchanged. The ready-assembled units cannot be opened by unauthorised persons without using force or special equipment.

**Mini USB stick**

The mini USB memory stick is incredibly small and stylish flash drive offering up to 8GB data storage. Measuring merely 31,3 x 12,4 mm, the mini USB drive is ideal for transporting data and fits inside optional lockable door **STD-99**. 2, 4 and 8 GB memory sticks available.

