

GE 8115

metrix
electronics

Differential probe for oscilloscopes

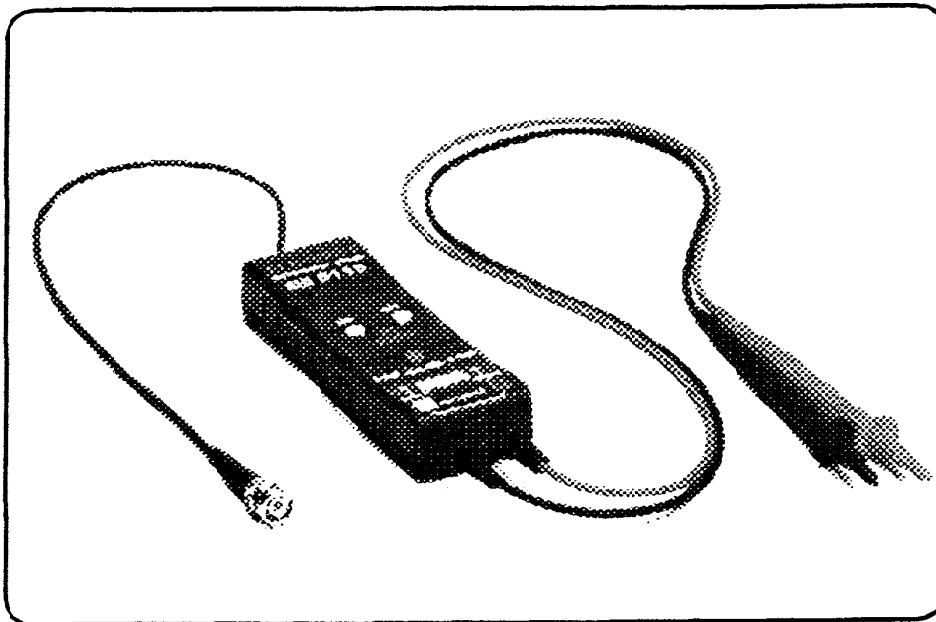

- 1500 V input voltage max.
- 30 MHz bandwidth
- x 100 and x 1000 attenuation
- > 50 dB CMRR (1MHz)
- User-friendliness through a microcontroller
- Automatic Switch-off
- Beep appears when overrange
- Low battery indication
- Battery operation with external supply option

CE IEC 1010 Cat III

ELDITEST
ELECTRONIC

Contents

1. Safety precautions
2. Items supplied with the probe
3. Introduction to the differential probe
4. Technical features.
5. Using the probe
6. Maintenance and repair
7. Examples of differential probe applications

1. Safety precautions

Prior to using the differential probe for the first time, read the following carefully :

- The probe must only be used by qualified personnel.
- Earthing the probe : This probe is designed to be Class 1 (connected to a protective conductor) so, apply carefully the following connecting procedure: By means of the BNC output socket, connect the probe to the oscilloscope in order to earth it. It is therefore necessary to check that the oscilloscope itself is connected to earth via a lead which conforms to regulations. Then connect the probe to the oscilloscope, prior to connecting the leads to the item to be tested. It is imperative not to disconnect the probe from the oscilloscope until after the test leads have been disconnected.
- Use only high quality accessories which conform to safety standards.
- Never open the probe whilst the input leads are connected.
- Never exceed the maximum input voltage of ± 1500 V DC + peak AC (IEC 1010-1 Cat. III).
- Do not expose the probe to humidity, steam or an aggressive or explosive environment.
- Keep the case and the connection leads in a clean condition and prevent humidity or liquid from being able to penetrate inside the probe or its component parts.
- Do not use the probe if there is any reason to think that it is not operating properly or that it is faulty.
- The mains power supply must conform to the standards in force.
- If the probe is not to be used for a prolonged period, remove the battery, so that it will not damage the battery compartment.

2. Items supplied with the probe

The differential probe is supplied with the following :

1	Differential probe	1	9 V monobloc battery 6LF22
2	safety test tips	1	operating instructions

Symbols used

The following safety signs are used on the probe and in these instructions:

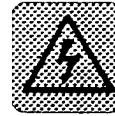

Caution, dangerous voltage!

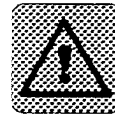

Caution, danger !

Read instructions !

3. Introduction to the differential probe

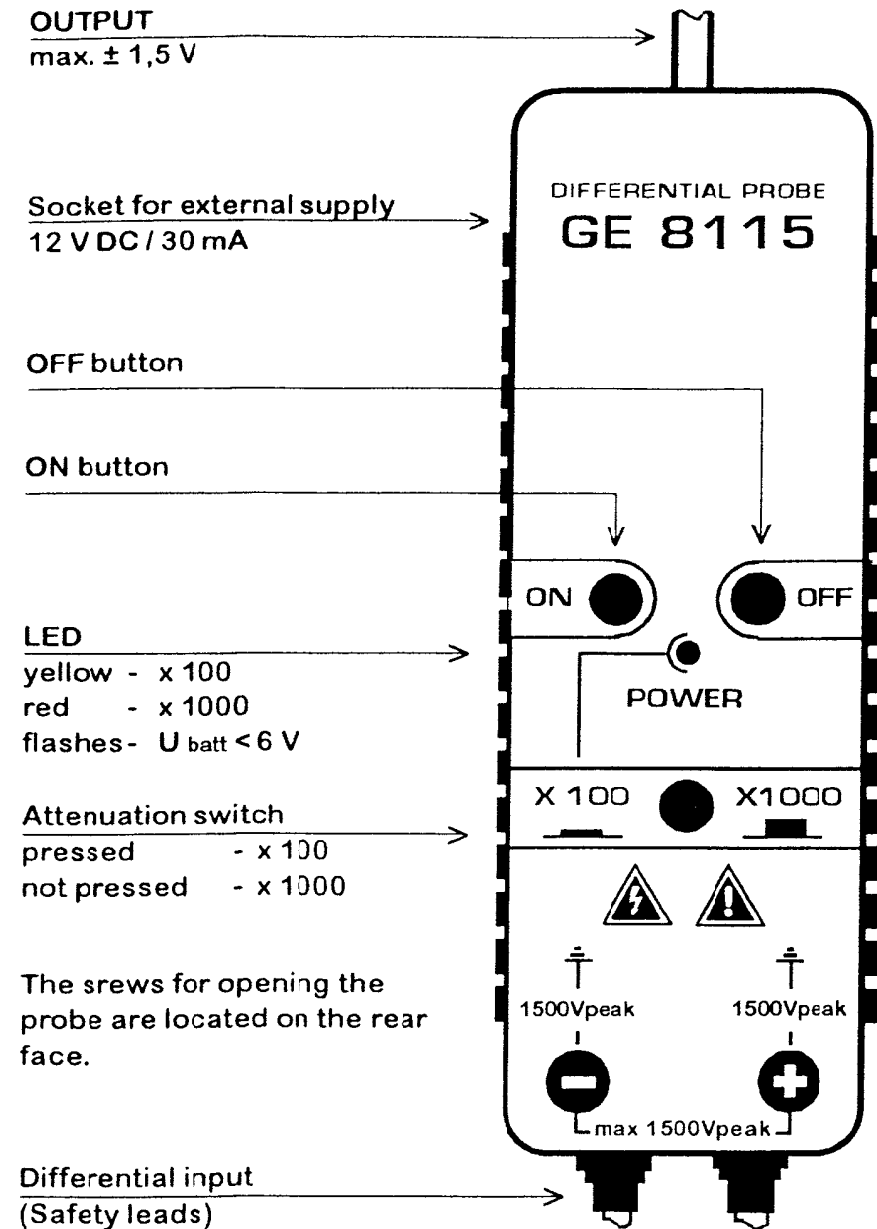

4. Technical characteristics

Input	Differential input voltage max. Common mode input voltage to earth Warning: both above conditions must be respected simultaneously.	$\pm 1500\text{V DC+AC}_{\text{Peak}}$ $\pm 1500\text{V DC+AC}_{\text{Peak}}$
Safety	Degree of pollution Installation category of input Operating temperature Storage temperature Relative humidity Input impedance Attenuation	IEC1010-2-031, Insulation: class 1 2, Indoor use, altitude < 2000m CAT III (*); 1500V max. to earth 0°C to +40°C -10°C to +60°C 80 % RH at 40°C 60M Ω 1.5 pF x 100 and x 1000
Frequency	Accuracy after 1 min. Bandwidth at x 100 Bandwidth at x 1000 Rise time at x 100 Rise time at x 1000	$\pm 3\%$ (18°C - 30°C) I 20 MHz 30 MHz 17.5 nsec 12 nsec
Output	Output voltage Output impedance Noise	max. $\pm 1.5\text{ V}$ (1M Ω) 50 Ω max. 1.5 mV
Supply	Common mode rejection ratio Battery Low battery indication Optional power supply Operating time on one battery Battery switch-off	DC: 70 dB AC: >50dB (at 1 MHz) 9V block LED flashes at $U_{\text{batt}} < 6\text{ V}$ 12V DC / 35 mA approx. 16 hours automatic, after 10 minutes
Accessories	2 safety test tips	red and black
Dimensions	Case (LxWxH) Weight Material Output cable length	157 x 60 x 26 mm 300 g with battery ABS, internal screening 50 cm

EMC:

This instrument has been designed in conformity with EMC standards in use and the compatibility has been tested regarding the following standards - EN 61326 (IEC 1326). The product herewith complies with the requirements of the low voltage directive 73/23/EEC and the EMC directive 89/336/EEC amended by 93/68/EEC. (*) Overvoltage category III is defined as follow: Fixed installation equipment (Examples: Industrial apparatus permanently connected to a fixed installation)

5. Using the probe



Before using the differential probe for the first time, read carefully the section on the precautionary measures at the beginning of these instructions.

● Inserting or replacing the 9 V battery

Before using the differential probe for the first time, the battery supplied with the device must be inserted in the battery compartment and connected up by means of the clip.

If the LED lamp (battery indicator) flashes during operation, the voltage of the battery has dropped to approximately 6 V. In order to ensure that the probe is operating correctly, it will then be necessary to replace the battery.



At the time of inserting or replacing the battery, the input leads must not be connected to an item to be tested! Never operate the probe with the case open.

To insert or replace the battery, remove the three screws on the rear face of the case and then open the probe. If necessary, the old 9 V battery can then be removed and insert the new one in the compartment. Always ensure not to damage or move the electronic components, in particular the control device. After inserting the new battery, close the case and tighten the three fastening screws.

● Usign an external power supply

Using the socket on the side of the probe, it is possible to connect the device to an external power supply. The internal battery is then disconnected and the battery saving automatic switch-off does not operate, indicated by a beep .

A mains transformer, for example, can be used for the external power supply. The power supply voltage must lie within the range of 9 - 16 V DC. The current consumption will be approximately 35 mA. Take into account the fact that the output voltage of some supplies considerably exceeds their nominal value !

Only use on external power supply that conforms with all the safety and EMC standards in force.

- **Connecting the probe**

Prior to connecting the probe, read the section on the safety precautions at the beginning of these instructions! Connect the output of the probe to the input of the oscilloscope, with the coaxial lead inserted into the BNC socket. The input impedance of the oscilloscope must be 1 MΩ. In view of the high impedance connection it is not advisable to extend the cable considerably.

In the case of using an oscilloscope incorporating a 50Ω input, the output voltage of the probe is reduced by half. It should also be taken into account the fact that consumption may also increase. In the case of a low impedance connection, it is possible to extend the cable without difficulty.

Use of the safety leads ensures reliable measurements up to a maximum voltage of ±1500V DC + peak AC. Should accessories be used which were not supplied with the probe, it is essential to check that they conform to safety standards!

- **Test equipment risk assesment**

Users of this equipment and or their employers are reminded than Health and Safety Legislation require them to carry out a valid risk assesment of all electrical work so as to identify the potential sources of electrical danger and risk of electrical injury such as from inadvertent short circuits. Where the assesment show that the risk is significant then the use of fused test leads constructed in accordance to the HSE guidance note GS38 „Electrical Test Equipment for use by Electricians“ should be used.

- **Switching the probe on and off**

The probe is switched on by pressing briefly on the CN button. The operating condition is indicated by the LED lamp lighting up and a short beep. Colour of the LED indicats attenuation: yellow - x100, and red - x1000. The device can be switched off by pressing briefly on the OFF button.

In order to increase the life of the battery, the device switches itself off automatically after an operating time of 10 minutes. The automatically switch off is independent of the input signal. If the ON button is pressed again before the end of this period, the operating time is again reset to 10 minutes. It is possible, to switch off the automatic shutoff timer by pressing the ON button longer then 1 sec. The automatic shutoff facility is cancelled when an external supply is connected.

<u>Button or operation</u>	<u>result</u>	<u>beep</u>
ON briefly	device on	1 x (2 x when ext. supply is indicated)
ON briefly, when device is on	auto off reset	1 x
ON longer than 1 sec	auto off off	2 x
external supply on	auto off off	2 x
external supply off	auto off on and reset	1x
auto off after 10 min	device off	3 x 2
OFF briefly	device off	1 x
input voltage >150V at x100		continual
input voltage >1500V at x1000		continual

● Choice of attenuation

The probe offers the choice of two attenuation factors : x 100 and x1000.

For an attenuation factor of x 100 (selector depressed, LED is lighting yellow), the voltage at the inputs is equal to the voltage displayed on the oscilloscope x 100.

For an attenuation factor of x 1000 (selector not depressed, LED is lighting red), the voltage at the inputs is equal to the voltage displayed on the oscilloscope x 1000.

● Procedure for using the differential probe

- Check the mains earth connection to the oscilloscope
- Connect the probe to the oscilloscope.
- Adjust the vertical sensitivity on the oscilloscope (V/div.).
- Select the attenuation factor on the probe (x 100 or x 1000).
- Switch the probe ON.
- If necessary, adjust the reference line on the oscilloscope.
- Connect the test leads to the item to be tested.

6. Maintenance and repair



The differential probe does not require any special maintenance. If necessary, clean the case with a damp cloth. Ensure that no moisture enters inside the device.

Do not use the probe if there is any reason to think that it is not operating properly or that it is faulty.

In the case of repair, send the device to the distributor. Do not attempt to service or repair the probe yourself.

7. Examples of differential probe applications

● Reference potential and safety

The measuring inputs of a normal mains operated oscilloscope are referenced to mains earth potential because they are connected, via the oscilloscope power cord, to the mains earth. Also, other exposed metal parts of the oscilloscope are connected to earth. Therefore, if an oscilloscope is connected to measure live mains circuits such as switching controllers, thyristors or power MOSFETs then this can cause short circuits damaging the system components and extreme user safety hazards.

These safety hazards still exist if the oscilloscope earth is disconnected or if it is powered through a mains isolating transformer because the oscilloscope input and other metal parts will be raised to the test circuit voltage. However, the use of differential probes provides safe single or multi-channel measuring connections.

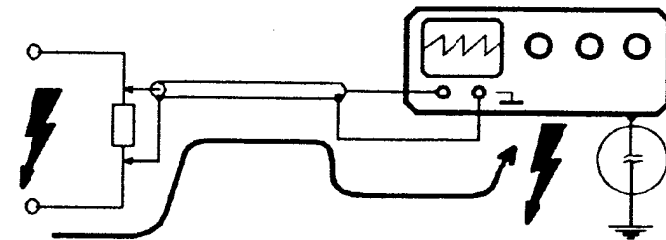

The oscilloscope casing may carry lethal voltages when the ground lead is detached.

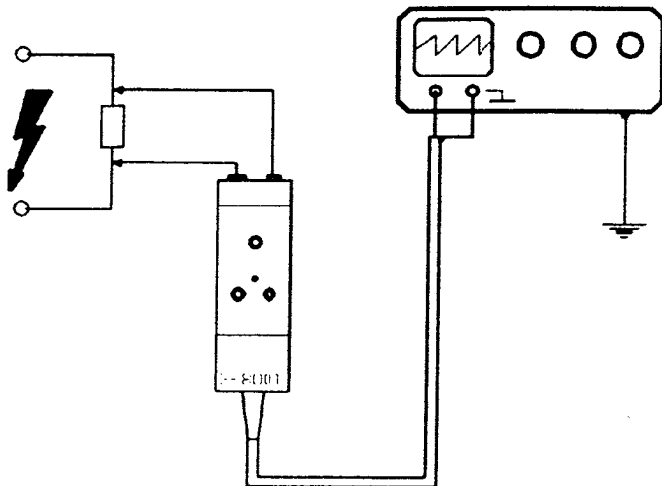

Differential probe for safe measurements

Apart from the danger which exists when taking measurements with floating potential, further problems arise in multi-channel measurements because ground connections still exist between the oscilloscope inputs. Using a differential probe ensures safety. This probe allows measurements between any two points of a circuit without a reference point. However, since the output is related to ground, it can be easily connected to the input of the earthed oscilloscope.

- **Earth loop circuits and common mode voltages**

Whilst the ground potential can in principle be used as a common reference point in many cases, it is often impossible to make reference connections to the same common point. This may create earth loops which means that a voltage may build up between the ground potential of the investigated circuit and the ground potential of the oscilloscope. It can be greater than the signal voltage and falsify the measuring result. The use of a differential probe is frequently the only solution in such cases or when a high common-mode voltage is present.

Highly accurate measurements largely unaffected by interference voltages can be made thanks to the high degree of common-mode rejection offered by the differential probe and the possibility of tapping the measuring voltage direct at the signal source.

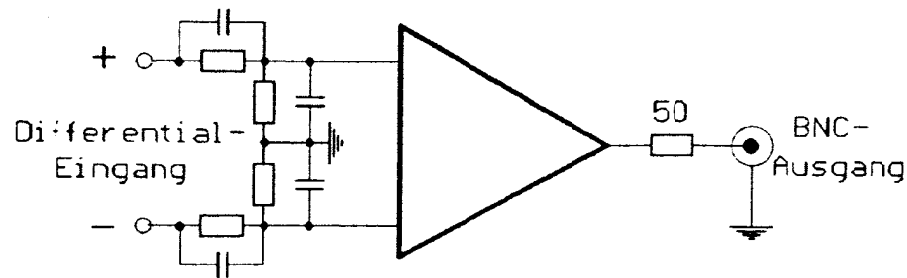

Differential probe principle

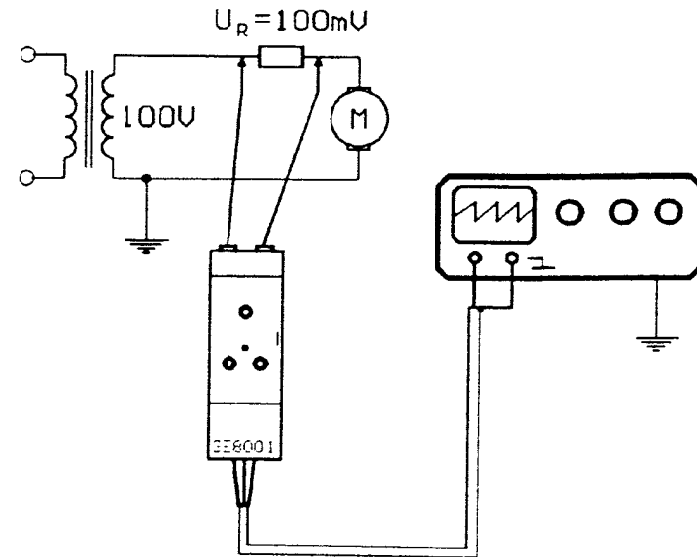

Example: Voltage at the motor series resistor is only a fraction of the common-mode voltage which is superimposed on the measuring voltage.

The differential probe expands each oscilloscope input to provide differential input connections for safe measuring on floating potential circuits. The probe also provides rejection of common mode signals.