

User manual INDICATOR SWP-99X/SWT-99X

- Firmware: **v.3.40 (b1)** or higher
- S-Toolkit: **v.2.1.0** or higher

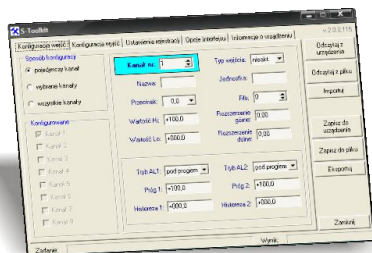

Read the user's manual carefully before starting to use the unit or software.
Producer reserves the right to implement changes without prior notice.

CONTENTS

I. USER MANUAL FOR INDICATOR.....	<u>4</u>
1. BASIC REQUIREMENTS AND USER SAFETY.....	<u>4</u>
2. GENERAL CHARACTERISTICS.....	<u>5</u>
3. TECHNICAL DATA.....	<u>6</u>
4. DEVICE INSTALLATION.....	<u>10</u>
4.1. UNPACKING.....	<u>10</u>
4.2. ASSEMBLY.....	<u>11</u>
4.3. CONNECTION METHOD.....	<u>13</u>
4.3.1.Connections of current type inputs (SWP-99X).....	<u>16</u>
4.3.2.Connections of temperature type inputs (SWT-99X).....	<u>18</u>
4.4. MAINTENANCE.....	<u>19</u>
5. FRONT PANEL DESCRIPTION.....	<u>20</u>
6. PRINCIPLE OF OPERATION.....	<u>21</u>
6.1. MEASUREMENT MODE.....	<u>21</u>
6.1.1.Measurement ranges definition of current inputs (SWP-99X).....	<u>21</u>
6.1.2.Measurement ranges definition of RTD and TC inputs (SWT-99X).....	<u>22</u>
6.2. MODES OF RESULT PRESENTATION.....	<u>23</u>
6.2.1. "Single channel" mode.....	<u>24</u>
6.2.2."Graph" mode.....	<u>25</u>
6.2.3."Channels List" mode.....	<u>28</u>
6.3. PRINCIPLE OF OUTPUTS OPERATION.....	<u>30</u>
6.3.1.Alarms.....	<u>30</u>
6.3.2.Outputs control.....	<u>31</u>
6.3.3.Example of output control.....	<u>33</u>
7. DEVICE PROGRAMMING.....	<u>34</u>
7.1. PARAMETERS EDITION.....	<u>36</u>
7.1.1.Numeric and switching parameters ("LIST" - type).....	<u>36</u>
7.1.2. Text parameters.....	<u>37</u>
7.1.3."SLIDER" - type parameters.....	<u>38</u>
7.2. DESCRIPTION OF RESULTS PRESENTATION MODES MENU.....	<u>39</u>
7.2.1."Graph options" menu.....	<u>39</u>
7.2.2."Channels list options" menu.....	<u>39</u>
7.3. RESULTS PRESENTATION MODES MENU STRUCTURE.....	<u>40</u>
7.4. MAIN MENU DESCRIPTION.....	<u>41</u>
7.4.1."Device information" menu.....	<u>41</u>
7.4.2."Display options" menu.....	<u>41</u>
7.4.3."Input settings" menu (common parameters).....	<u>42</u>
7.4.4."Input settings" menu (SWP-99X).....	<u>43</u>
7.4.5."Input settings" menu (SWT-99X).....	<u>45</u>
7.4.6."Outputs settings" menu.....	<u>47</u>
7.4.7."Date & time settings" menu.....	<u>48</u>
7.4.8."RS485 port settings" menu.....	<u>48</u>
7.4.9."Access setup" menu.....	<u>50</u>
7.4.10."Language" parameter.....	<u>50</u>
7.4.11."Default settings" parameter.....	<u>50</u>
7.5. MAIN MENU STRUCTURE.....	<u>51</u>
8. THE MODBUS PROTOCOL HANDLING.....	<u>53</u>
8.1. LIST OF REGISTERS.....	<u>53</u>
8.2. TRANSMISSION ERRORS HANDLING.....	<u>58</u>
8.3. EXAMPLES OF QUERY/ANSWER FRAMES.....	<u>58</u>
9. USER'S SETTINGS LIST.....	<u>61</u>

II. USER MANUAL FOR “S-TOOLKIT”	<u>67</u>
1. GENERAL CHARACTERISTICS	<u>67</u>
2. INSTALLATION AND STARTUP	<u>67</u>
3. USING PROGRAM	<u>68</u>
3.1. “INPUTS SETTINGS” TAB.....	<u>69</u>
3.2. “OUTPUTS SETTINGS” TAB.....	<u>70</u>
3.3. “INTERFACE OPTIONS” TAB.....	<u>70</u>
3.4. “DEVICE INFORMATION” TAB.....	<u>72</u>
3.5. CONFIGURATION MODES.....	<u>72</u>
3.5.1. Individual configuration of channels.....	<u>73</u>
3.5.2. Configuring selected channels.....	<u>73</u>
3.5.3. Configuring all channels.....	<u>73</u>
3.6. UPDATING DEVICE FIRMWARE.....	<u>73</u>

Explanation of symbols used in the manual:



- This symbol denotes especially important guidelines concerning the installation and operation of the device. Not complying with the guidelines denoted by this symbol may cause an accident, damage or equipment destruction.

IF THE DEVICE IS NOT USED ACCORDING TO THE MANUAL THE USER IS RESPONSIBLE FOR POSSIBLE DAMAGES.



- This symbol denotes especially important characteristics of the unit. Read any information regarding this symbol carefully

I. USER MANUAL FOR INDICATOR

1. BASIC REQUIREMENTS AND USER SAFETY



- **The manufacturer is not responsible for any damages caused by inappropriate installation, not maintaining the proper environmental conditions and using the unit contrary to its assignment.**
- Installation should be conducted by qualified personnel . During installation all available safety requirements should be considered. The fitter is responsible for executing the installation according to this manual, local safety and EMC regulations.
- The unit must be properly set-up, according to the application. Incorrect configuration can cause defective operation, which can lead to unit damage or an accident.
- If the device is equipped with PE connector, it should be connected to PE wire.
- **If in the case of a unit malfunction there is a risk of a serious threat to the safety of people or property additional, independent systems and solutions to prevent such a threat must be used.**
- **The unit uses dangerous voltage that can cause a lethal accident. The unit must be switched off and disconnected from the power supply prior to starting installation of troubleshooting (in the case of malfunction).**
- Neighbouring and connected equipment must meet the appropriate standards and regulations concerning safety and be equipped with adequate overvoltage and interference filters.
- **Do not attempt to disassemble, repair or modify the unit yourself. The unit has no user serviceable parts. Defective units must be disconnected and submitted for repairs at an authorized service centre.**

2. GENERAL CHARACTERISTICS

- **Multifunctional**

Device is designed for displaying current values and presentation of technological parameter trends in graphic form.

- **Configurable measurement and control input**

The unit has up to 8 channels (depending on version) of measurement signals and one digital voltage input with programmable functions, e.g. control of the recording process. Each signal can be freely configured and described. Depending on device version all measured parameters must be available as current signals (0-20 mA or 4-20 mA standards for **SWP-99X**), voltage signals (0-5 V, 1-5 V, 0-10 V, 2-10 V standards for **SWP-99X**), K, S, J, T, N, R, B, E standards for **SWT-99X** and 60 mV, 75 mV, 100 mV, 150 mV standards for **SWT-99X**) or resistance (Pt100, Pt500 or Pt1000 standards for **SWT-99X**). The internal analogue-digital converter has a 12 or 16 bit resolution (depending on input type), which provides high measurement resolution results. Additionally, individual alphanumeric description (text) of each of the recorded channels is possible.

- **Fast serial interface**

The digital indicator is fitted with a galvanic isolation RS-485 interface, programmed with ModBus RTU transmission protocol. This enables the connection of a number of digital indicators into the network, remote collecting of data from each unit and also remote configuration. The application of the RS-485 interface instead of RS-232 is due to the possibility of achieving high transmission speeds using transmission lines of larger length than is possible with the RS-232 interface.

- **Wide range of power supply voltage and external sensor power supply**

The built-in pulse power supply allows power to be supplied to the unit with 85...**230**...260V AC/DC voltage or 16...**24**...35 AC, 19...**24**...50 DC voltage (depending on version). The digital indicator (version with current inputs only) is equipped with voltage output for powering the sensor and converters: 24V DC $\pm 5\%$ / max. 200mA.

- **Legible graphic display**

The 128 x 64 points display with a backlight mounted on front of the unit is a big advantage of the digital indicator. It allows the display of trend graphs for each channel separately. Different operation modes provide the possibility of selecting and adjusting the method of data presentation depending on the user's requirements. Additionally, it is possible to set the display to show one current value measured for a selected channel.

- **Easy configuration**

There are 6 keys on the front of the digital indicator that enable the configuration of the unit. The menu assisted with full text descriptions makes the unit configuration process quite easy. However, due to a significant number of configured parameters it is advised to use the attached configuration software for PCs.

3. TECHNICAL DATA

Power supply voltage (depending on version)	85... 230 ...260 V AC/DC; 50 ÷ 60 Hz (separated) or 19... 24 ...50 V DC and 16 V... 24 ...35 V AC
External Fuse (required)	(separated)
Power consumption	T - type, max. 2 A typically 7 VA; max. 12 VA
Measurement inputs (depending on version)	SWP-99X: up to 8 inputs 0÷5 V, 1÷5 V, 0÷10 V, 2÷10 V, 0÷20 mA or 4÷20 mA, common ground
	SWT-99X: up to 8 inputs Pt100, Pt500, Pt1000 (with manual connection switch 2 or 3-wire), K, S, J, T, N, R, B, E, 0÷60 mV, 0÷75 mV, 0÷100 mV or 0÷150 mV
Digital outputs	2 electronic relays, NO type, 24 V AC / 35 V DC / max. 200 mA, overload protection
Communication interfaces	RS-485, 8N1 / Modbus RTU, galvanic isolated: 1 min @ 500 V DC., 1200 bit/s ÷ 115200 bit/s., USB PC
Display	LCD graphic display, 128 x 64 points, with backlight
Backlight color	white or amber
Protection level	IP 65 (front panel, optional version with mounting hole sealing available) IP 20 (housing and terminals)
Housing type	panel mounting
Housing material	NORYL - GFN2S E1
Housing dimensions	96 x 96 x 100 mm
Mounting hole	90,5 x 90,5 mm
Assembly depth	102 mm
Panel thickness	max. 5 mm
Operating temperature (depending on version)	0 °C to +50 °C
Storage temperature (depending on version)	-20 °C to +50 °C
Humidity	-10 °C to +70 °C
Altitude	-20 °C to +70 °C
	5 to 90% no condensation
	up to 2000 meters above sea level
Screws tightening max. torque	0,5 Nm
Max. connection leads diameter	2,5 mm ²
Safety requirements	according to: PN-EN 61010-1 installation category: II pollution degree: 2 voltage in relation to ground: 300 V AC insulation resistance: >20 MΩ insulation strength between power supply and input/output terminal: 1 min. @ 2300 V (see Fig. 3.1)

EMC

PN-EN 61326-1



Device described in this manual is available in two versions differed by measurement inputs type. This manual contain following short descriptions:

- SWP-99X** - means device with type of inputs: voltage (0÷5 V, 1÷5 V, 0÷10 V, 2÷10 V)
 current (0÷20 mA, 4÷20 mA)
- SWT-99X** - means device with type of inputs: TC (K, S, J, T, N, R, B, E)
 RTD (Pt100 / Pt500 / Pt1000)
 mV (0÷60 mV, 0÷75 mV, 0÷100 mV lub 0÷150 mV)

Parameters of current type inputs (SWP-99X)

Input type	0÷5 V, 1÷5 V, 0÷10 V, 2÷10 V, 0÷20 mA or 4÷20 mA, common ground
Measurement range	± 9999 plus decimal point
Current measurement accuracy	± 0.1% @ 25 °C; ± one digit (for 0÷10 and 0÷20 mA range)
Temperature stability	50 ppm / °C
Sampling rate	8 sps
Accepted prolonged input overload	20%
Voltage input resistance	60 kΩ
Current input resistance	100 Ω
Sensor power supply output	24 V DC ± 5% / max. 50 mA, Not insulated from measurement inputs
Current input protection	50 mA auto-reset fuse

Parameters of TC, RTD and mV type inputs (SWT-99X)

Thermocouple input	K, S, J, T, N, R, B, E
Measurement ranges	K: -200 °C ÷ 1370 °C -328 °F ÷ 2498 °F S: -50 °C ÷ 1768 °C -58 °F ÷ 3214 °F J: -210 °C ÷ 1200 °C -346 °F ÷ 2192 °F T: -200 °C ÷ 400 °C -328 °F ÷ 752 °F N: -200 °C ÷ 1300 °C -328 °F ÷ 2372 °F R: -50 °C ÷ 1768 °C -58 °F ÷ 3214 °F B: 250 °C ÷ 1820 °C 482 °F ÷ 3308 °F E: -200 °C ÷ 1000 °C -328 °F ÷ 1832 °F
Measurement accuracy	K, J, E: ± 0.1% @ 25 °C; ± one digit N: ± 0.2% @ 25 °C; ± one digit S, T, R, B: ± 0.5% @ 25 °C; ± one digit
Accuracy of cold ends temperature compensation	± 1 °C
RTD input	Pt100, Pt500 or Pt1000 (with manual connection switch 2 or 3-wire)
Measurement range	-100 °C ÷ +600 °C -148 °F ÷ +1112 °F
Measurement accuracy	± 0.1% @ 25 °C; ± one digit
Measurement wires resistance	max. 20 Ω (every wire)
Voltage input (150 mV)	0÷60 mV, 0÷75 mV, 0÷100 mV, 0÷150 mV
Measurement accuracy	± 0.1% @ 25 °C; ± one digit (for 0÷150 mV range)
Input resistance	> 1,5 MΩ
Accepted prolonged input overload	20,00%
Temperature stability	50 ppm / °C
Display range	-999 ÷ 9999 (for RTD mode – see above)
Common ground	

Sampling rate depends on available number of inputs in the device and selected type of input:

	RTD	TC	mV
1 channel	c.a. 500 ms	c.a. 250 ms	c.a. 250 ms
2 channels	c.a. 1 s	c.a. 400 ms	c.a. 400 ms
4 channels	c.a. 1,4 s	c.a. 600 ms	c.a. 600 ms
8 channels	c.a. 2,6 s	c.a. 1 s	c.a. 1 s

Tab. 3.1. Sampling rate in relation to number and selected type of input



- Cables connected to RTD inputs can not be longer than 30 meters and must be laid completely in building.
- When 2-wire connection method is used, the wires should be as short as possible.
- When 3-wire connection method is used, the wires should be even.

Software (Windows environment)

- **S-Toolkit**, PC software for indicator easy configuring,



This is a class A unit. In a residential or a similar area it can cause radio frequency interference. In such cases the user can be requested to use appropriate preventive measures.



Carefully check that the isolation used with the unit (**Fig. 3.1**) meets the expectations and if necessary use appropriate measures of overvoltage protection. Additionally, insure the appropriate air and surface insulation gaps when installing (**Tab. 3.2**).

Range of operating voltage	Air gap [mm]	Surface gap [mm]
Up to 50V RMS or DC	0,2	1,2
Up to 100V RMS or DC	0,2	1,4
Up to 150V RMS or DC	0,5	1,6
Up to 300V RMS or DC	1,5	3,0

Tab. 3.2. Minimal insulation gaps according to EN 61010-1

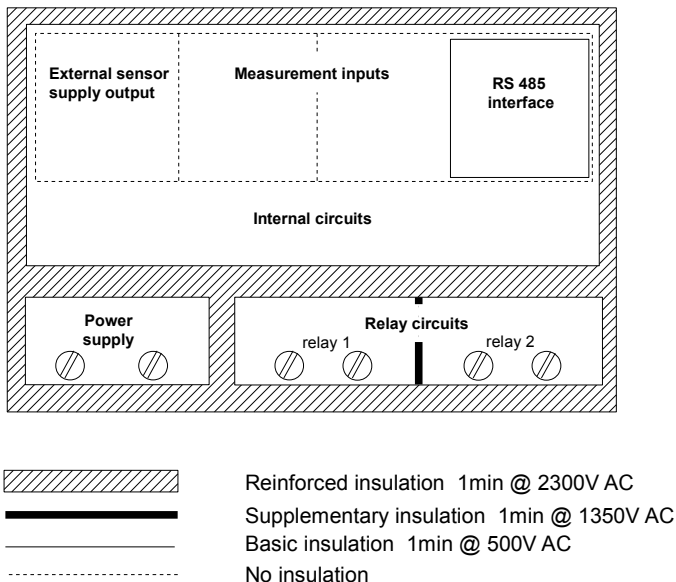

Fig. 3.1. Schematic diagram showing the insulation between individual circuits of the unit.

4. DEVICE INSTALLATION

The unit has been designed and manufactured in a way assuring a high level of user safety and resistance to interference occurring in a typical industrial environment. In order to take full advantage of these characteristics installation of the unit must be conducted correctly and according to the local regulations.



- Read the basic safety requirements on page 4 prior to starting the installation.
- Ensure that the power supply network voltage corresponds to the nominal voltage stated on the unit's identification label.
- The load must correspond to the requirements listed in the technical data.
- All installation works must be conducted with a disconnected power supply.
- Protecting the power supply connections against unauthorized persons must be taken into consideration.

4.1. UNPACKING

After removing the unit from the protective packaging, check for transportation damage. Any transportation damage must be immediately reported to the carrier. Also, write down the unit serial number located on the housing and report the damage to the manufacturer.

4.2. ASSEMBLY



- The unit is designed for mounting inside housings (control panel, switchboard) insuring appropriate protection against surges and interference. Metal housings must be connected to ground in a way that complies with the governing regulations.
- Disconnect the power supply prior to starting assembly.
- Check the connections are wired correctly prior to switching the unit on.

In order to install the unit, a 90,5 x 90,5 mm mounting hole (**Fig. 4.1**) must be prepared. The thickness of the material of which the panel is made must not exceed 5mm. When preparing the mounting hole take the grooves for catches located on both sides of the housing into consideration (**Fig. 4.1**). Place the unit in the mounting hole inserting it from the front side of the panel, and then fix it using the brackets (**Fig. 4.3**). The minimum distances between the center points of multiple units - due to the thermal and mechanical conditions of operation - are 115 mm x 115 mm (**Fig. 4.5**).

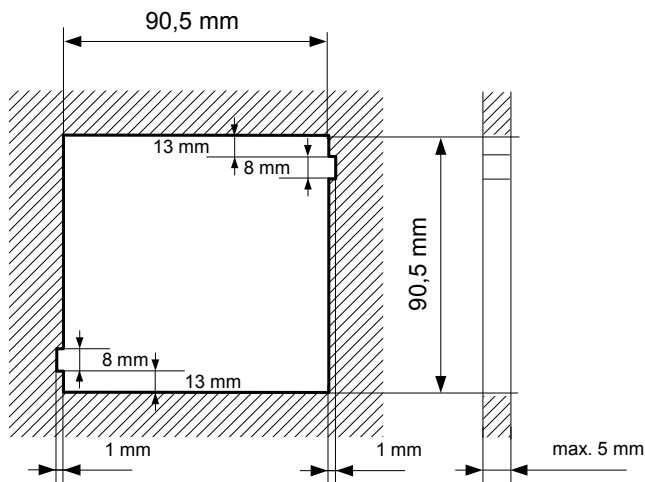

Fig. 4.1. Recommended mounting hole dimensions

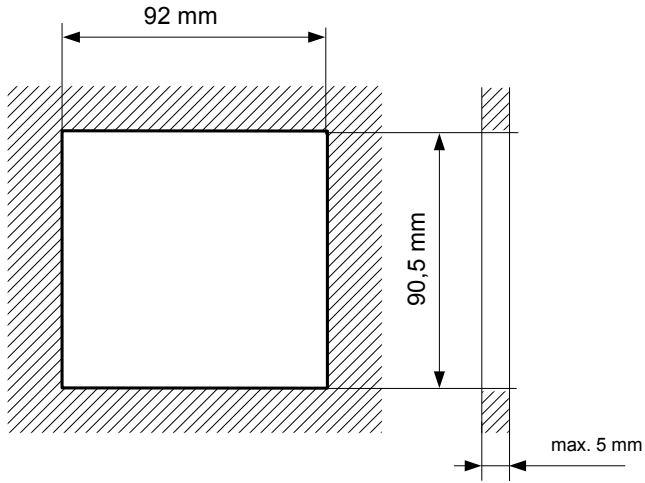

Fig. 4.2. Allowable mounting hole dimensions

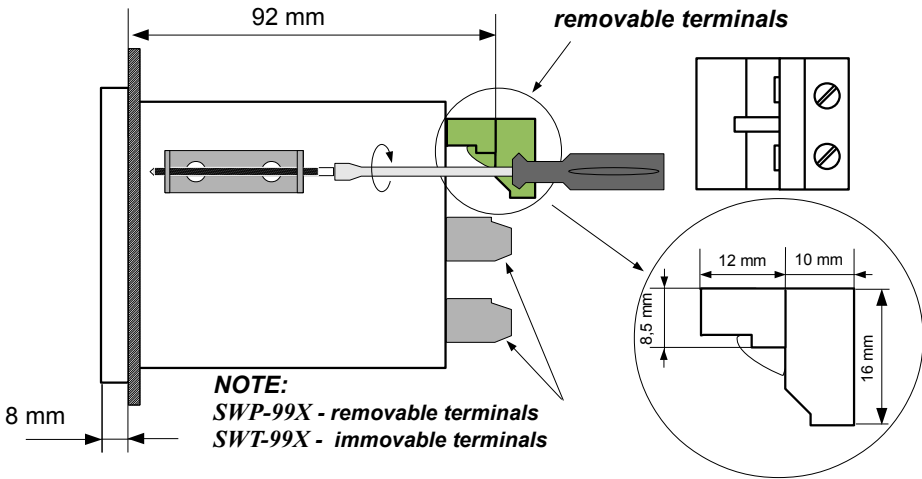

Fig. 4.3. Installing of brackets, and dimensions of connectors.

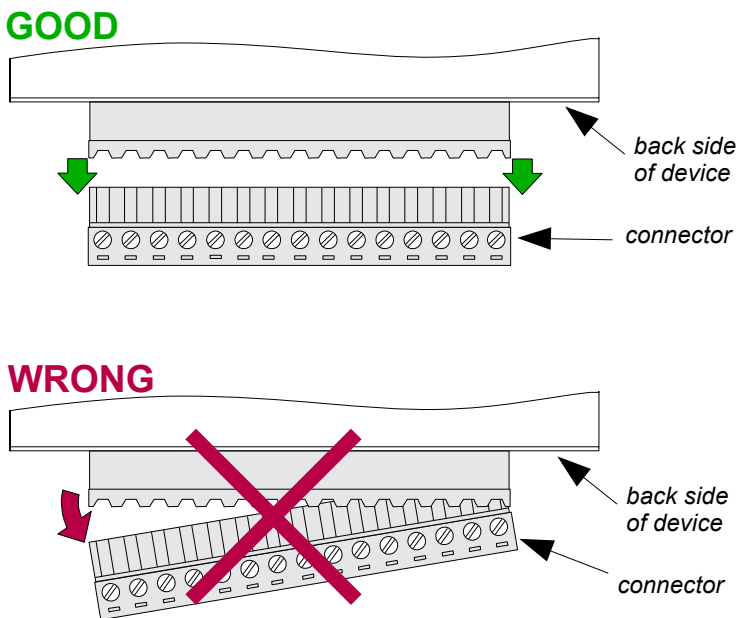

Fig. 4.4. Connectors removing method

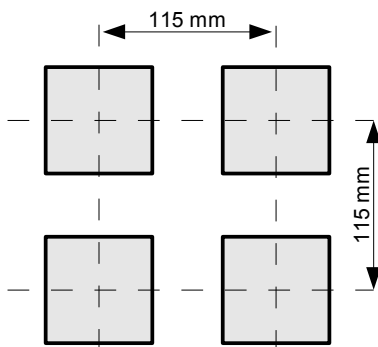

Fig. 4.5. Minimum distances when assembly of a number of units

4.3. CONNECTION METHOD

Caution



- Installation should be conducted by qualified personnel. During installation all available safety requirements should be considered. The fitter is responsible for executing the installation according to this manual, local safety and EMC regulations.



- The unit is not equipped with an internal fuse or power supply circuit breaker. Because of this an external time-delay cut-out fuse with a small nominal current value must be used (recommended bipolar, max. 2A) and a power supply circuit-breaker located near the unit. In the case of using a monopolar fuse it must be mounted on the phase cable (L).
- The power supply network cable diameter must be selected in such a way that in the case of a short circuit of the cable from the side of the unit the cable shall be protected against destruction with an electrical installation fuse.
- Wiring must meet appropriate standards and local regulations and laws.
- In order to secure against accidental short circuit the connection cables must be terminated with appropriate insulated cable tips.
- Tighten the clamping screws. The recommended tightening torque is 0.5 Nm. Loose screws can cause fire or defective operation. Over tightening can lead to damaging the connections inside the units and breaking the thread.
- The separable clamps should be inserted into appropriate connectors in the unit, even if they are not used for any connections.
- **Unused terminals (marked as n.c.) must not be used for connecting any connecting cables (e.g. as bridges), because this can cause damage to the equipment or electric shock.**
- If the unit is equipped with housing, covers and sealing to, protecting against water intrusion, pay special attention to their correct tightening or clamping. In the case of any doubt consider using additional preventive measures (covers, roofing, seals, etc.). Carelessly executed assembly can increase the risk of electric shock.
- After the installation is completed do not touch the unit's connections when it is switched on, because it carries the risk of electrical shock.

Due to possible significant interference in industrial installations appropriate measures assuring correct operation of the unit must be applied. To avoid the unit of improper indications keep recommendations listed below.

- Avoid running signal cables and transmission cables together with power supply cables and cables controlling inductive loads (e.g. contactors). Such cables should cross at a right angle.
- Contactor coils and inductive loads should be equipped with interference protection systems, e.g. RC-type.
- Use of screened signal cables is recommended. Signal cable screens should be connected to the earthing only at one of the ends of the screened cable.
- In the case of magnetically induced interference the use of twisted pair of signal cables is recommended. Twisted pair (best if shielded) must be used with RS-485 serial transmission connections.
- In the case of interference from the power supply side the use of appropriate interference filters is recommended. Bear in mind that the connection between the filter and the unit should be as short as possible and the metal housing of the filter must be connected to the earth with the largest possible surface. The cables connected to the filter output must not be run with cables with interference (e.g. circuits controlling relays or contactors).

Connections of power supply voltage and measurement signals are executed using the screw connections on the back of the unit's housing.

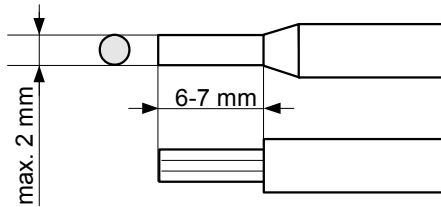
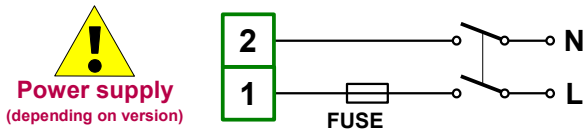

Fig. 4.6. Method of cable insulation replacing and cable terminals dimensions



All connections must be made while power supply is disconnected !



Depending on version:
 85...**230**...260 V AC/DC or
 19...**24**...50 V DC; 16...**24**...35 V AC

Fig. 4.7. Connection of power supply

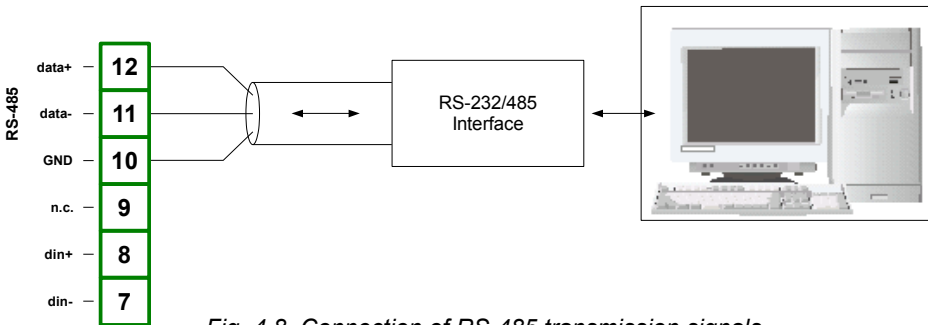

Fig. 4.8. Connection of RS-485 transmission signals

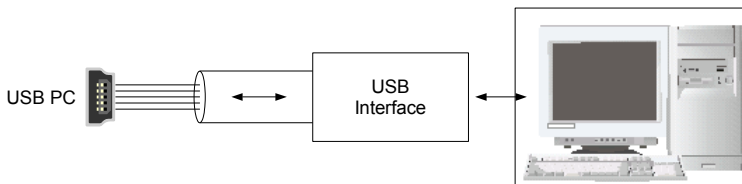

Fig. 4.9. Connection of USB transmission signals

4.3.1. Connections of current type inputs (SWP-99X)

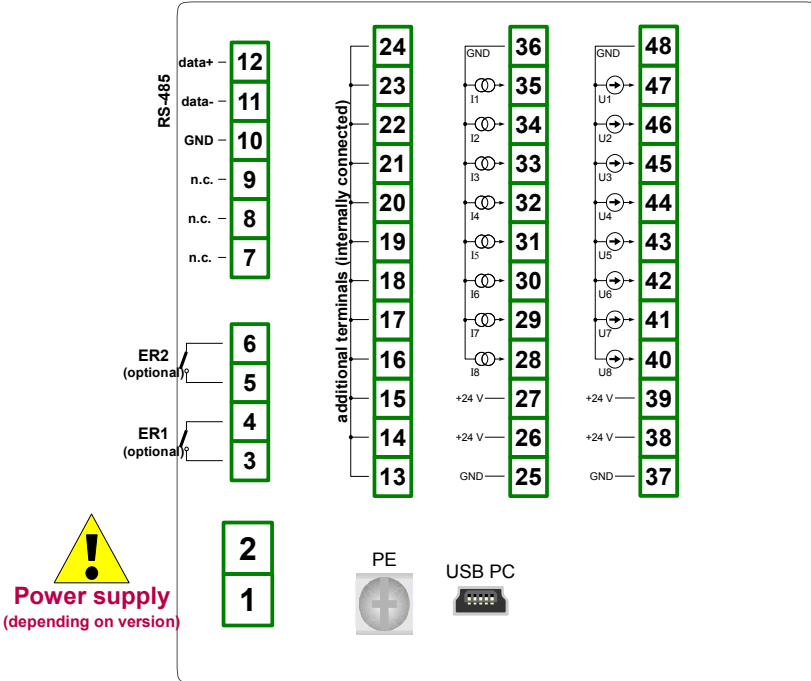

Fig. 4.10. Terminals description (SWP-99X)

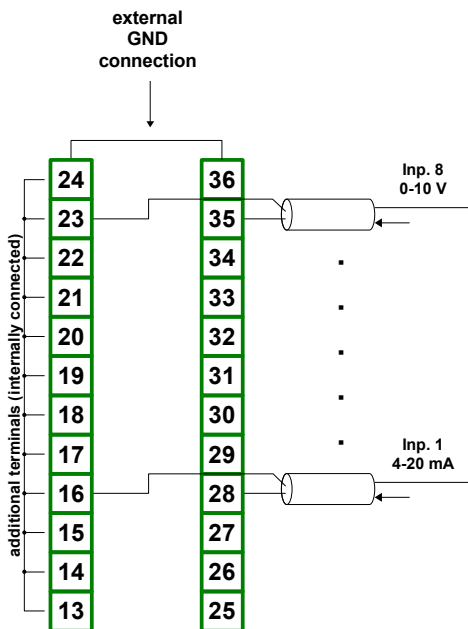

Fig. 4.11. Connections of current signals of active sensors (current signal 0-20 mA or 4-20 mA and ground)

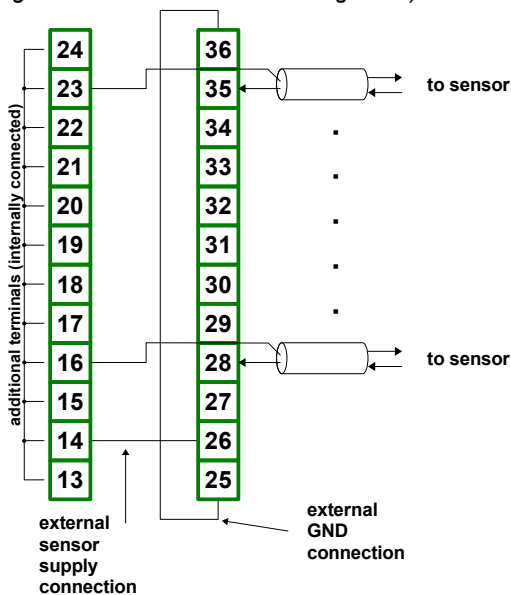

Fig. 4.12. Connections of current signals of 2-wire sensors (sensor power supply voltage and 4-20 mA signal)

4.3.2. Connections of temperature type inputs (SWT-99X)

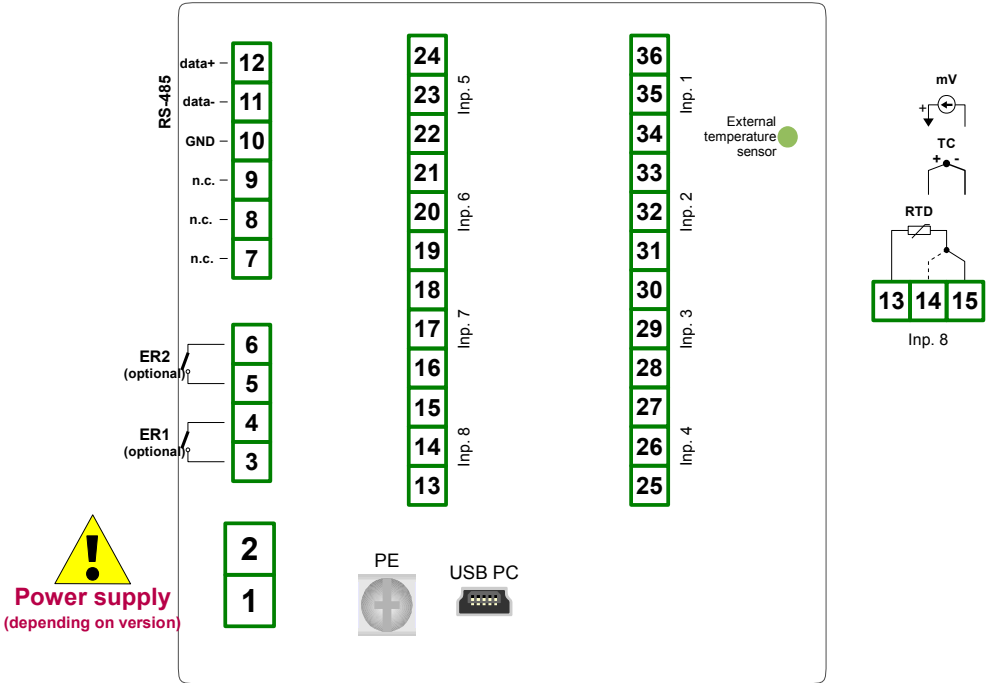

Fig. 4.13. Terminals description (SWT-99X)



Fig. 4.14. External connection for channel no 1:
a) TC sensors; b) mV sensors

The Pt100 / Pt500 / Pt1000 sensor can be connected to the device in typical 3-wire circuit (Fig. 4.15 a) or 2-wire circuit (Fig. 4.15 b). Due to precision of measurement 3-wire circuit is recommended.



If 2-wire circuit is used, the resistance of wires should be as small as possible, to avoid of measurement errors. Measured value can be corrected (constant correction) using „Bias” parameter from menu „Input settings”. Due to low precision 2-wire connection is not recommended.

When 2-wire connection is used, the resistance of particular wires ($R_a \div R_c$) **NEEDN'T BE DIFFERENT** (should be as small as possible) When 3-wire connection is used, the resistance of particular wires ($R_a \div R_c$) **MUST BE IDENTICAL** to enable proper compensation of it's resistance. The resistance of particular wire **should not be greater than 20 Ω** .

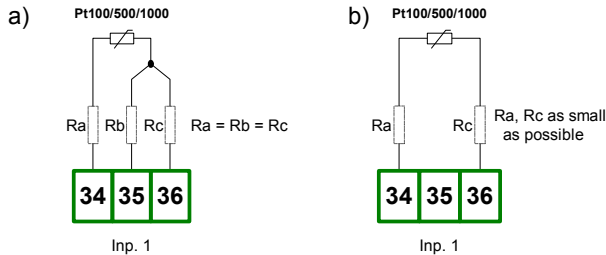

Fig. 4.15. Connection of Pt100 sensors for channel no 1:
a) 3-wire circuit; b) 2-wire circuit;



The connection circuit should not be changed while unit is powered. Every change of connection while the unit is powered causes measurement errors by several seconds after change.

4.4. MAINTENANCE

The unit does not have any internal replaceable or adjustable components available to the user. Pay attention to the ambient temperature in the room where the unit is operating. Excessively high temperatures cause faster ageing of the internal components and shorten the fault-free time of the unit's operation.

In cases where the unit gets dirty do not clean with solvents. For cleaning use warm water with small amount of detergent or in the case of more significant contamination ethyl or isopropyl alcohol.



Using any other agents can cause permanent damage to the housing.



Product marked with this symbol should not be placed in municipal waste. Please check local regulations for disposal of electronic products.

5. FRONT PANEL DESCRIPTION

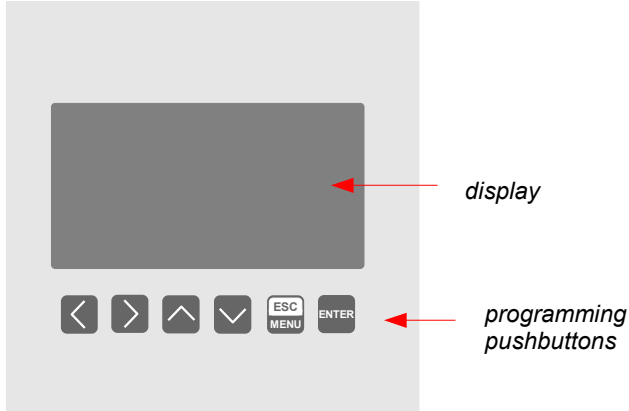

Key designation and functions



Symbols used in the manual: **[ESC/MENU]**

Functions:

- go to main menu (press and hold by at least 2 sec.),
- go to result presentation modes menu,
- exit the current level and return to previous menu (or to one of result presentation modes),
- cancellation of changing the edited device parameter.



Symbols used in the manual: **[ENTER]**

Functions:

- start editing parameter,
- go to submenu,
- confirm change of edited parameter.



Symbols used in the manual: **[<] [>]**

Functions:

- change the horizontal cursor position,
- modify edited device parameter
- change of channel number in one of four result presentation modes and during measurement channel configuration.



Symbols used in the manual: **[^] [v]**

Functions:

- change the vertical cursor position,
- modify edited device parameter,
- change of channel result presentation mode.

6. PRINCIPLE OF OPERATION

After turning the power supply on, the logo and basic unit data are showed on the display, then the unit goes to the measurement mode.

6.1. MEASUREMENT MODE

In the measurement mode the unit executes the measurement of values of signals connected to measurement inputs, hereafter called measurement channels (the number of available channels depends on the unit version). For each channel measurements are conducted at the frequency of 1 time per second (**I** and **U** inputs), 1 time per 2.5 seconds (**RTD** inputs) or 1 time per second (**TC** input). The results of the conducted measurements are shown on the LCD display. The unit computes the measurement results into indicated values proportionally (linear).

All available parameters of the unit's operation can be configured in the main menu (see **DEVICE PROGRAMMING**) or using the RS-485 interface and software installed on your PC.



Configuration of the device (via menu or RS-485 interface) **do not stops measures.**

Results of measurements conducted for active (selected by the user) channels of the unit are displayed in one of the available result presentation modes (see **RESULT PRESENTATION MODES**).

6.1.1. Measurement ranges definition of current inputs (SWP-99X)

The nominal range of input current (voltage) for each input is 0-20 mA or 4-20 mA (0-5 V, 1-5 V, 0-10 V or 2-10 V) and can be extended to the maximum of 0-24 mA (0-6 V or 0-12 V), independently to each measurement channel. The range of measurement results corresponding to the nominal range of input current (voltage) is defined as **user defined range**. The range of measurement results corresponding to the range of input current (voltage) including the extensions is defined as **allowable measurement range** (Fig. 6.1 and Fig. 6.2). All values presented as sliders are scaled due to **user defined range**. Graph is scaled due to **allowable measurement range**.

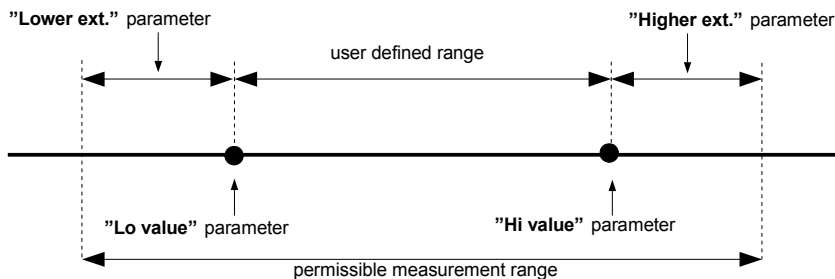

* "Lower ext." parameter is only significant for an input current range of 4-20 mA.

Fig. 6.1. Definition of measurement ranges (**I** input)

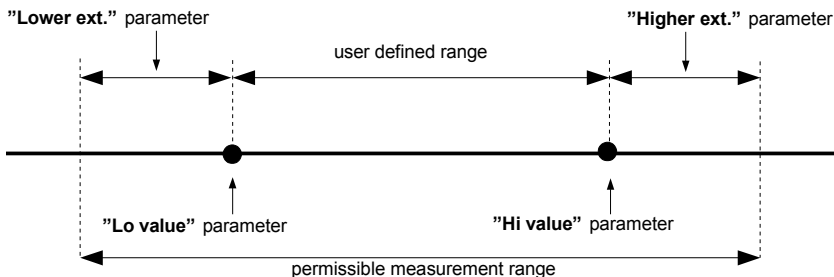

* "Lower ext." parameter is only significant for an input current range of 1-5 V and 2-10 V.

Fig. 6.2. Definition of measurement ranges (*U input*)

The range of displayed values, unit of measured value and position of the decimal point (for presentation in numeric form) and name of channel are defined by the user.

6.1.2. Measurement ranges definition of RTD and TC inputs (SWT-99X)

The range of every input's measured signal is selectable, and user defined as **user defined range**. All values presented in graphic form (graphs, sliders) are scaled due to **user defined range**. The range of the results referred to maximum hardware performances is defined as **allowable measurement range** (Fig. 6.3, Fig. 6.4 and Fig. 6.5).

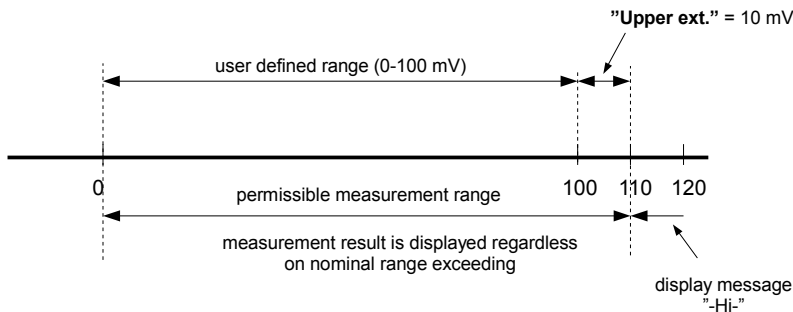

Fig. 6.3. Definition of measurement ranges (*mV input*)

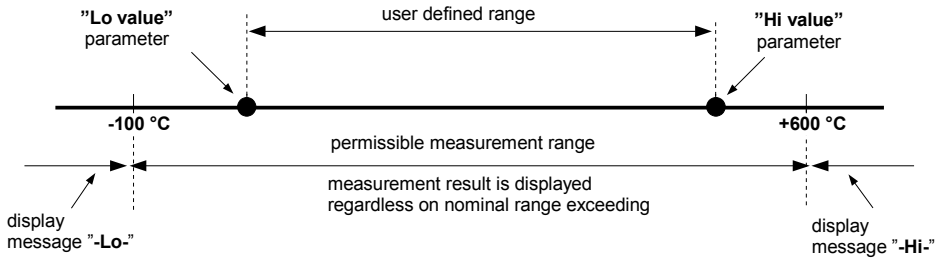

Fig. 6.4. Definition of measurement ranges (RTD input)

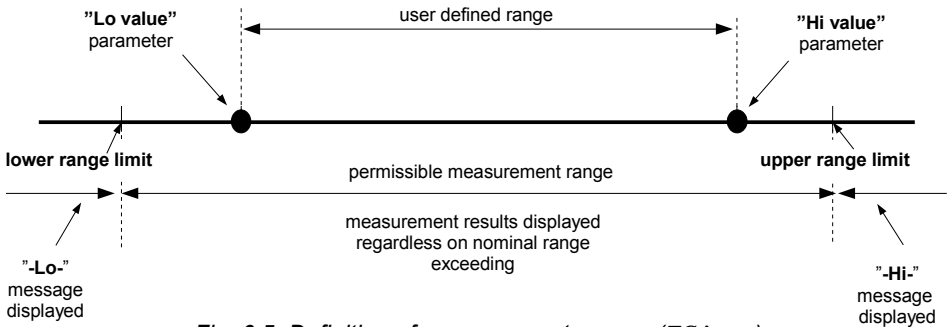
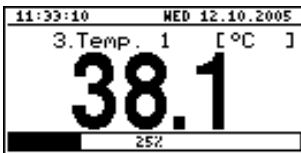

Fig. 6.5. Definition of measurement ranges (TC input)

The range of the displayed values, type of input signal, scale bias, and name of the channel are defined by the user.

6.2. MODES OF RESULT PRESENTATION

The results of measurements conducted for active channels are presented in numeric or graphic (graph or bar) form. Selection of one of the available results presentation modes can be made using the [**^**] and [**v**] keys in the measurement mode. Configuration of the method of displaying in the selected results presentation mode can be made in the menu of the given presentation mode (see **DESCRIPTION OF RESULTS PRESENTATION MODES MENU**). The following presentation modes are available:



- "**Single channel**" mode (Fig. 6.6) enables the last measurement for one of the measurement channels to be viewed in the numeric and graphic form (bar).

Fig. 6.6. "Single channel" mode

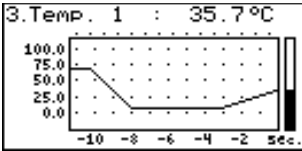

Fig. 6.7. "graph" mode

- "Graph" mode (Fig. 6.7) enables the momentary values or averaged values of measurements conducted for one of measurement channels to be viewed in the form of a graph.

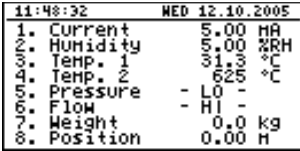

Fig. 6.8. "Channels list" mode (values)

- "Channels list" mode (Fig. 6.8, 6.9) enables the measurement results for all active measurement channels to be viewed in numeric or graphic (bar) form.

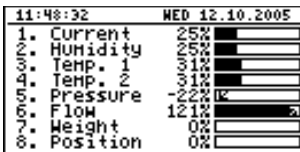

Fig. 6.9. "Channels list" mode (bars)



After starting the unit the result presentation mode and channel selected prior to switching off the unit are active (this information is stored in the EEPROM memory)

6.2.1. "Single channel" mode

This mode (Fig. 6.10) displays the result of the last measurement for one of the active channels in numeric form (in the middle part of the display) and in the form of a bar (percentage, at the bottom of the screen). The graphical indicator (bar) always shows the relation of the measurement result to the **user defined range** (see description of "Hi value", "Lo value" parameters in the "Inputs settings" menu).

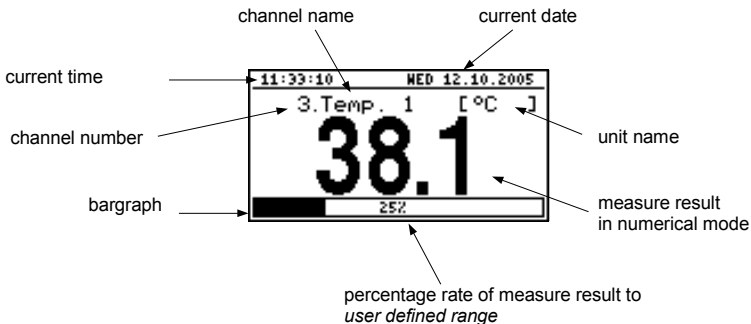

Fig. 6.10. Unit in "Single channel" result presentation mode

Exceeding the user defined range (**Fig. 6.11**) is signalled on the bar with an arrow indicating the direction of exceeding the range. If the measurement result for one channel exceeds the allowable measurement range (**Fig. 6.12**) instead of the result in numeric form the display shows a **"-Hi-"** or **"-Lo-"** message (depending on the direction of exceeding).

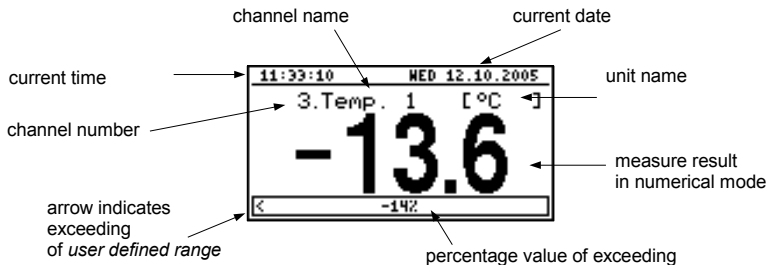

Fig. 6.11. Exceeding user defined range in **"Single channel"** mode

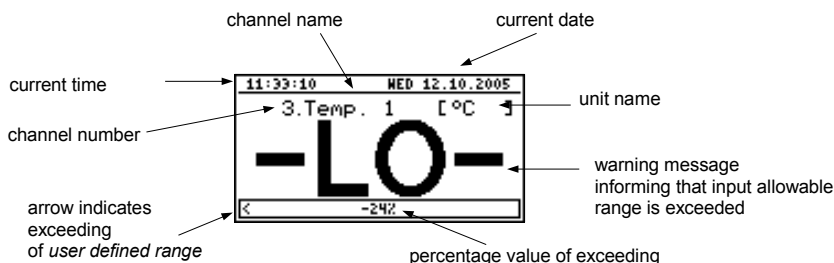

Fig. 6.12. Exceeding allowable range in **"Single channel"** mode

Functions of keys in **"Single channel"** mode:



- go to main menu (press and hold for approx. 2 seconds),



- change channel number,



- change results presentation mode.

6.2.2. **"Graph"** mode

In the case of memorization momentary values in this mode (**Fig. 6.13**) the display shows measurement results in the form of a graph, numeric form and in the form of a vertical bar. Numeric values (displayed over the graph) and vertical bar (displayed to the right of the graph) indicate the value corresponding to the result of the current measurement, irrespective of the set time scale of the graph. The graphical indicator (bar displayed to the right of the graph) always indicates the measurement result to the **graph scale range** ratio (see description of **"Hi value"** **"Lo value"** parameters in the **"Inputs settings"** menu).



Depending on measurement inputs type **graph scale range** is defined as:

- for SWP-99X - **graph scale range** = **allowable measurement range**
- for RTD input (SWT-99X)
 - **graph scale range** = **user defined range**
- for TC input (SWT-99X)
 - **graph scale range** = **user defined range**

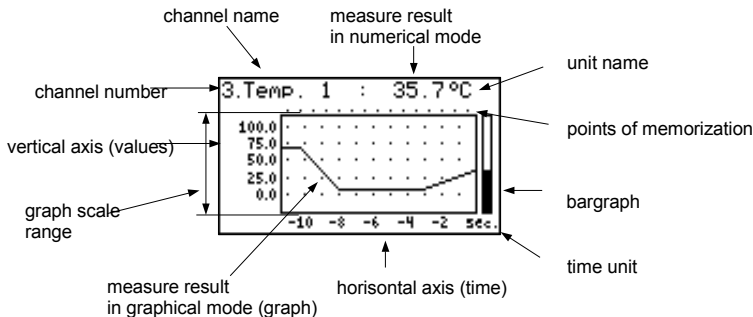

Fig. 6.13. Unit in "Graph" result presentation mode

Exceeding the **graph scale range** (Fig. 6.14, 6.15) is announced on the bar in the form of an arrow indicating the direction of exceeding the range. If the measurement result for the given channel exceeds the **graph scale range** (Fig. 6.14, 6.15) instead of the current numeric value (displayed in the upper right corner) the display shows a "-Hi-" or "-Lo-" message (depending on the direction of exceeding).

warning message informing that input graph scale range is exceeded

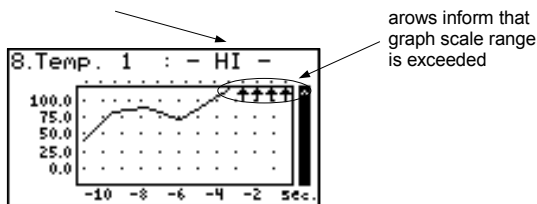
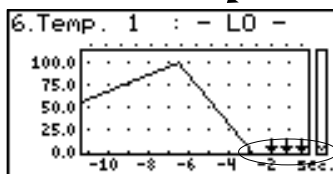

Fig. 6.14. Exceeding the upper limit of the graph scale range

The display shows points corresponding to measurement results. Directly after switching to the "Graph" mode the display shows points of the graph corresponding to measurement results recorded so far. The points that are displayed next, correspond to the results of conducted measurements. Therefore, if there are recorded measurement results in the unit's memory, they shall be displayed directly after switching to the "Graph" mode, otherwise (no recorded measurements) the graph points corresponding to measurements results shall be plotted from the time this mode is switched on. If the measurement result for the given channel exceeds the **graph scale range**, then instead of the graph point corresponding to the measurement result, the display shows an arrow indicating the direction of exceeding the range (Fig. 6.14, 6.15). Above the upper limit of graph window the display shows points

corresponding to the measurement recording times. The vertical scale of the graph covers the values defined for the **graph scale range**.

warning message informing that input graph scale range is exceeded



arrows inform that graph scale range is exceeded

Fig. 6.15. Exceeding lower limit of the graph scale range

In the case of recording averaged values all points of the graph, concerning values recorded in the unit's memory, constitute averaged measurement results. Indicators (numeric, bar) and points of the graph, corresponding to current values refer to the momentary measurement value.

When recording averaged measurement results exceeding the **allowable measurement range** is understood as exceeding of this range by at least one of the measurements to be averaged.

In the case of the upper limit, lower limit, or both limits of measurement range being exceeded in the given **recording period**, values represented in the form of arrows indicating the direction of exceeding (up, down, or both directions) will be recorded in the unit's memory instead of the averaged results.

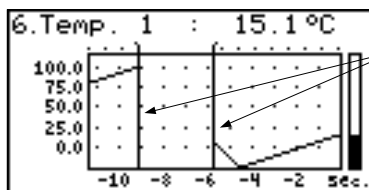

vertical line informs about breaks in registration (power turn off) or configuration change

Fig. 6.16. Breaks in registration or change of configuration in "Graph" mode

Changes of settings configuring the operation of a given channel and operation stoppage are signalled in the form of a vertical line (Fig. 6.16).



If the settings of the horizontal scale (time scale) will be too big (time/point) in relation to speed of changes of the measurement signal, the graph can become illegible. If this is the case, change the time scale settings. The horizontal scale settings (time scale) can be changed in the "Graph options" menu. In order to go to the "Graph options" menu press the [ESC/MENU] key.



Functions of keys in "Graph" mode:



- go to main menu (press and hold for approx. 2 seconds),
- go to "Graph options" menu, description on page 39,



- change channel number,

- 

 • change results presentation mode.

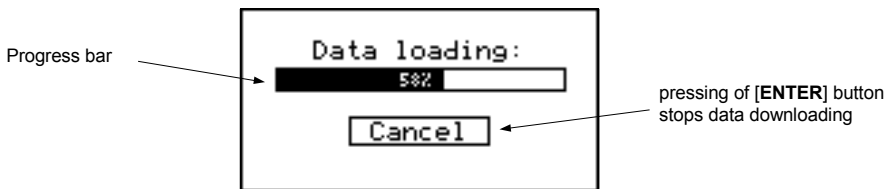

Fig. 6.17. Message displayed when loading data to be displayed on the graph

i If downloading the data (recorded measurement results) necessary for displaying the graph takes more than 1 second an appropriate message is displayed (Fig. 6.17). Pressing [ENTER] will stop the data downloading process and display a graph made on the basis of the data downloaded so far. "X" will be displayed instead of data that was not downloaded (Fig. 6.18).

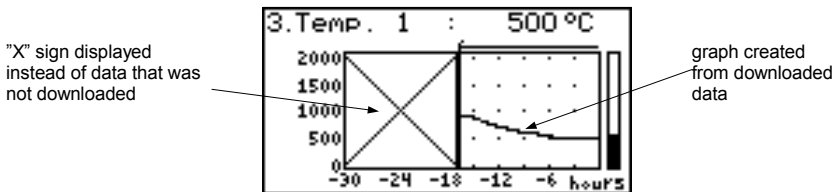

Fig. 6.18. Display in "Graph" mode in the case where data download was stopped.

6.2.3. "Channels List" mode

In this mode (Fig. 6.19, 6.20) the display shows the results of the current measurements for the active channels of the unit. The measurement results can be presented in numeric form or in the form of a bar (percentage) depending on the settings in the "Channels list options" menu. Graphic indicators (bars) always show the measurement result to the **user defined range** ratio.

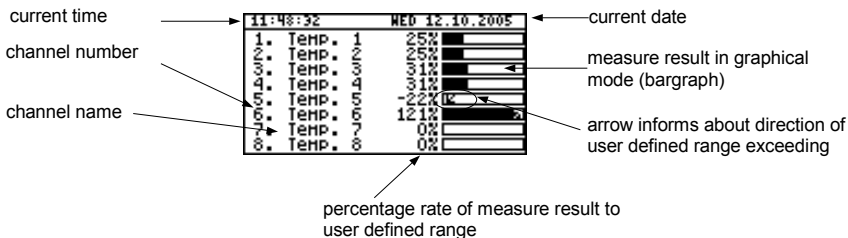

Fig. 6.19. Unit in "Channels list" results presentation mode. "Channels list options" parameter set as "bar graphs".

Exceeding the **user defined range** is signalled on the bars in the form of an arrow indicating the direction of exceeding the range. If the measurement result for a given channel exceeds the **allowable measurement range**, instead of the current result in numeric form the display shows a "-Hi-" or "-Lo-" message (depending on the direction of exceeding). Press the [ESC/MENU] key to go to "Channels list options" menu.

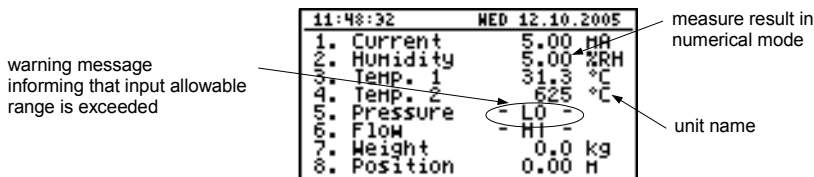

Fig. 6.20. Unit in "Channels list" results presentation mode. "Channels list options" parameter set as "values".

Functions of keys in "Channels list" mode:



- go to main menu (press and hold for approx. 2 seconds),
- Go to "Channels list options" menu, description on page 39.



- change channel number,



- change results presentation mode.

6.3. PRINCIPLE OF OUTPUTS OPERATION

Device is equipped in electronic relay outputs that can be used to control external devices. Each output has own icon (in left upper corner **Fig. 6.21**) that shows the status of the output.

Relays are controlled by alarms defined in **"Inputs settings"** menu and additional parameters in **"Outputs settings"** menu.

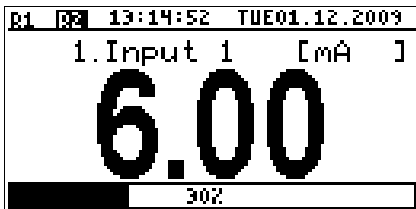

Fig. 6.21. Screen with relay 1 open and relay 2 closed.

6.3.1. Alarms

Each channel can generate two independent alarms. Particular alarm is present when entered condition is met. Those conditions can be set in **"Inputs settings"**.

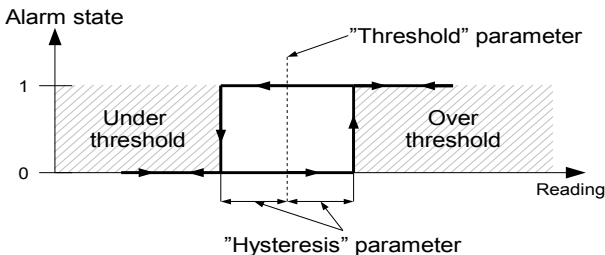

Fig. 6.22. **"Over threshold"** mode diagram. 0 means alarm not present, 1 alarm present

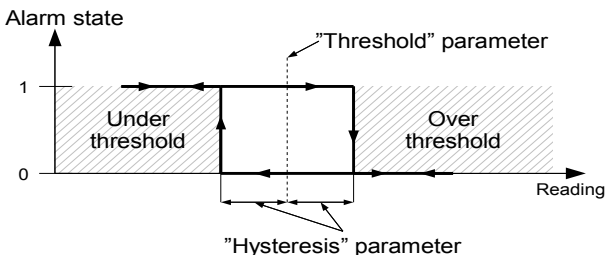

Fig. 6.23. **"Under threshold"** mode diagram. 0 means alarm not present, 1 alarm present

6.3.2. Outputs control

Device outputs are controlled by logic function of channels alarms. There are two logic functions: OR – closes (or opens, if output channel mode is set to N.C.) the relay when **any** of attached channels is in alarm state, AND - closes (or opens, if output channel mode is set to "N.C.") when **all** of attached channels are in alarm state.

A particular channel is in alarm state when condition selected in "Outputs settings: Source" is met. For example when "alarm 2" option is selected for channel 1 the channel 1 will be in alarm state **if and only if** alarm 2 will be present, state of alarm 1 does not mater in this case. If option „alarm 1 and 2" is selected, channel will be in alarm state **if and only if** alarm 1 and alarm 2 will be present in the same time.

"Mode" parameter describes output mode. If "N.O." is selected then relay will be closed when logic function is 1, and open in the other case. If "N.C." is selected then relay will be open when logic function is 1 and closed in the other case.

Fig. 6.24 shows example reading followed by rely state. Rely state can be changed only when times (t_A, t_B, t_C, t_D) are greater than delays times. If those delays times are set to "0" the switch state is taken as soon as condition appears. If those delay parameters are set to value greater than "0" relay switch state is taken (point B_{ON}, D_{ON} , chart: a, d, e) when delay time is elapsed.

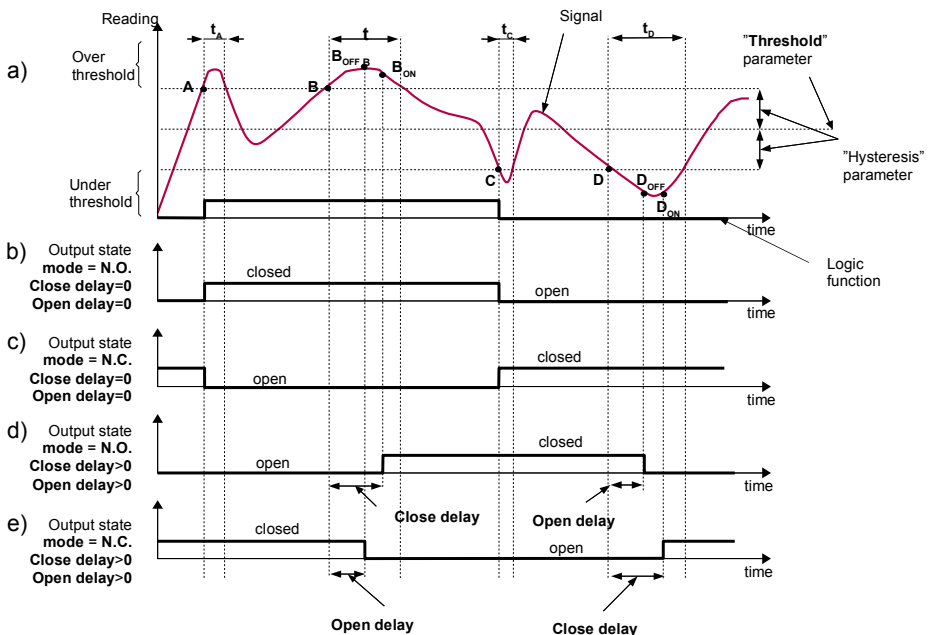

Caption:

A, B, C, D, E – signal border crossing points.

$B_{ON}, B_{OFF}, C_{ON}, C_{OFF}, E_{ON}, E_{OFF}$ - relay switch state moments for chart d and e

t_A, t_B, t_C, t_D, t_E - times when displayed values are in measurement zones Over and Under threshold

Fig. 6.24. Relay controlled by one alarm "Over threshold" mode ("Closed hold time and "Open hold time" set to 0).

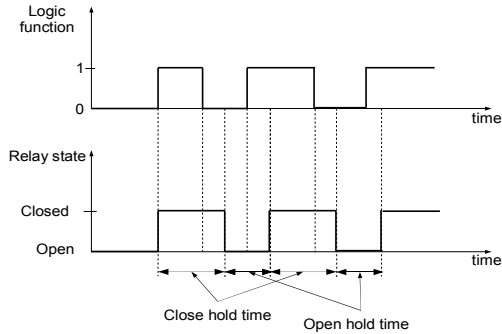

Fig. 6.25. Working relay diagram in "N.O." mode. "Open hold time" and "Closed hold time" greater than 0, "Open delay" and "Close delay" equals 0.

Additional parameters shown in Fig. 6.26 are "Closed hold time" and "Open hold time". Those parameters cause current output state to hold for desired time. When output is hold alarms states are no consider therefore no delays times are counted until hold time elapsed.

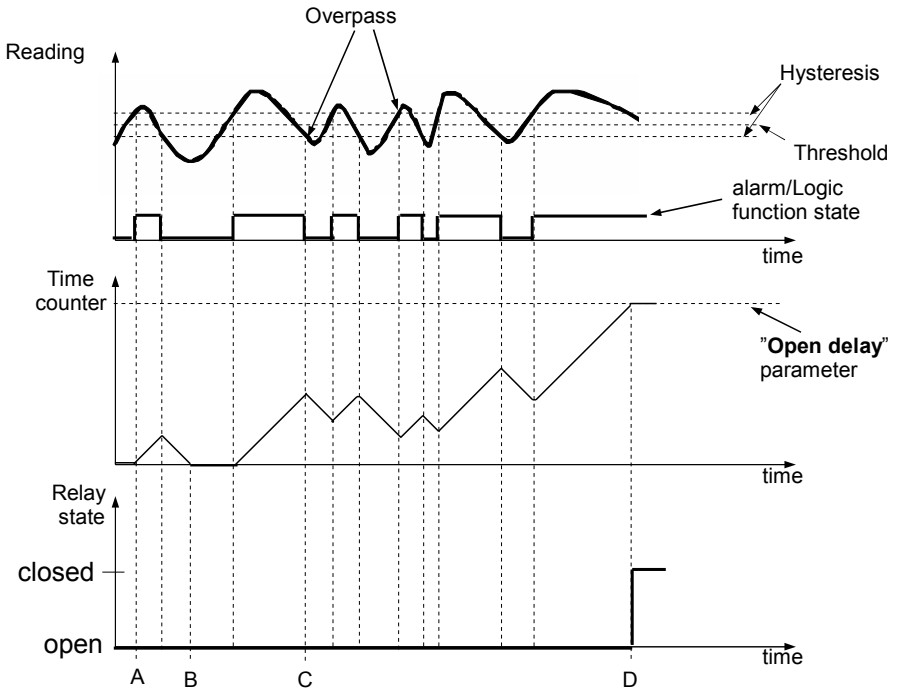

Fig. 6.26. Working output controlled by single channel alarm with large reading oscillations. Alarm mode - "over threshold", "Open hold time" and "Closed hold time" equals 0, "Open delay" and "Close delay" greater 0.

In case of often threshold overpass (large readings oscillations) the "Close delay" and "Open delay" parameters in opposite to "Closed hold time" and "Open hold time" will delay switching output state until internal time counter reaches entered value. The counter is counting up (to the entered value) when logic function is **1** and counting down to **0** when logic function is **0**. The way how it works is described in Fig. 6.26.

6.3.3.Example of output control



Outputs have limited current rating. **Do not** use outputs to supply external devices that requires a lot of power like heaters, motors or others. Instead, use external supply devices like power relays or others that can be controlled by output.

If simple temperature control in some room is required this device can be used to do this. Assuming there is a heater and cooler that we can control by outputs and single temperature sensor. We must connect a sensor to some input, output 1 to control the heater and output 2 to control the cooler. The input channel where temperature sensor is connected must be configured correctly (in this example it is assumed reading is in Celsius degree).

If lower limit of the temperature when heater should be turned on is 18 degree and upper limit when cooler should be turned on is 27 degree, alarm settings should be as follows (assuming decimal point "0.0"):

"AL1 mode" - "*under threshold*"

"Threshold 1" - **19.0**

"Hysteresis 1" - **1.0**

"AL2 mode" - "*over threshold*"

"Threshold 2" - **26.0**

"Hysteresis 2" - **1.0**

When alarm 1 is generated this means that the temperature reaches 18 degree (**19.0 – 1.0**). When temperature reaches 20 degree (**19.0+1.0**) alarm 1 will disappear. Similar, when temperature reaches 27 degree (**26.0 + 1.0**) alarm 2 will appear and when temperature reaches 25 degree (**26.0 – 1.0**) alarm 2 will disappear.

Now we have to configure outputs to use those alarms. In "Outputs settings" menu following example parameters must be set:

Output 1 (heater control)

"Mode" - "**N.O.**"

"Logic funct." - "**AND**"

"Source:channel 1" - "**alarm 1**" - heater alarm

"Close delay" - "**120.0**" - heater turning on delay

"Open delay" - "**30.0**" - heater turning off delay

"Closed hold time" - "**180.0**" - minimal time that heater should work

"Open hold time" - "**150.0**" - minimal time that heater should be turned off

Output 2 (cooler control)

"Mode" - "N.O."

"Logic funct." - "AND"

"Source:channel 1" - "alarm 2" - cooler alarm

"Close delay" - "120.0" - cooler turning on delay

"Open delay" - "30.0" - cooler turning off delay

"Closed hold time" - "180.0" - cooler time that heater should work

"Open hold time" - "150.0" - cooler time that heater should be turned off

For those settings the heater and cooler will work as assumed.

7. DEVICE PROGRAMMING

Defining the method of displaying measurement results in the selected results presentation mode can be done in the presentation mode menu. The meaning of individual parameters available for selected modes of results presentation is described in the **DESCRIPTION OF RESULTS PRESENTATION MENU MODES** section. In order to get to the configuration menu of selected results presentation mode, press the **[ESC/MENU]** key in the current results presentation mode.



The settings can also be edited, from the PC, using the software provided by the manufacturer, after connecting the device via the RS-485 port or USB PC port.

The unit's main menu (**Fig. 7.1**) enables necessary information about the unit to be obtained and allows the setting of all parameters of the unit related to operation of measurement channels, communications using the RS-485 interface, LCD display, access settings, and other. The meaning of particular parameters of the unit is described in section **MAIN MENU DESCRIPTION**.

To access the main menu press down and hold for approx. 2 seconds the **[ESC/MENU]** key in any results presentation mode.

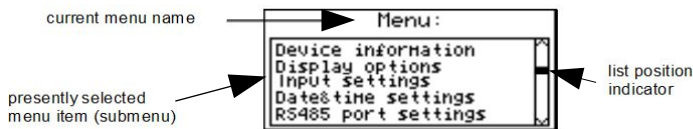

Fig. 7.1. Main menu of the unit

If the "Password" option in the "Access setup" menu was defined, then the user will have to provide the password (**Fig. 7.2**) before proceeding to menu options (the password is entered the same way as changing a numeric parameter, see **EDITING PARAMETERS**).

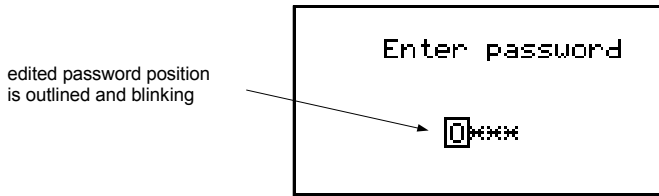

Fig. 7.2. Password requested when accessing unit's main menu.

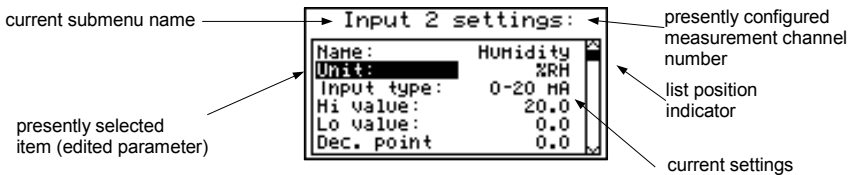

Fig. 7.3. Example of submenu

Functions of the buttons while sub-menu and parameters choice:



- Change the number of the configured channel (only in "Inputs settings" submenu).



- Change of current item in the menu (selecting a lower level menu or parameter for editing). The selected option is distinguished by displaying the option name in negative (bright lettering on dark background).



- The function of the **[ENTER]** key depends on the type of current menu item:
- if the menu item corresponds to one of the unit's parameters, pressing **[ENTER]** starts parameter editing,
 - if the menu item selects a lower level menu, pressing **[ENTER]** activates the new menu.



- The **[ESC/MENU]** key exits the current menu level and returns to a higher order menu (to one of the results presentation modes).



After approximately 1 minute since the last activation of the keys, the unit returns from any level to one of the results presentation modes (only if no parameters are in editing mode).

7.1. PARAMETERS EDITION

To start edition of any parameter user should select name of desired one using **[^]** **[v]** buttons and then **[ENTER]**.

7.1.1. Numeric and switching parameters ("LIST" - type)

Numeric parameters constitute a series of digits that form a number in decimal format. Entering a new parameter value (**Fig. 7.4**) consists of changing the values of selected digits within the allowable range (using the **[^]**, **[v]** keys). Some numeric parameters can take negative values (e.g. "**Hi value**" parameter). In such cases the "-" mark can be selected on the first decimal position of the parameter.

Switching parameters (**Fig. 7.5**) can be presented in the form of a list, out of which only one of the options available on the list can be selected for the given parameter. Options of switching parameter are selected using **[^]**, **[v]** keys.

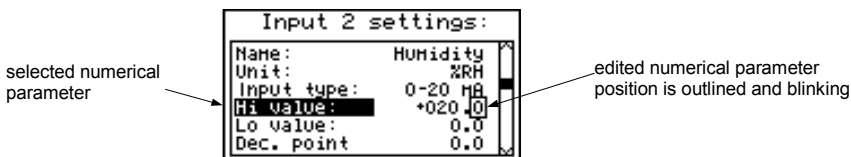

Fig. 7.4. Editing numerical parameter

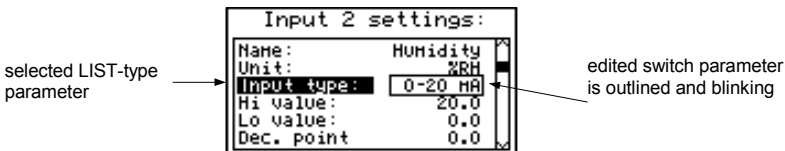

Fig. 7.5. Editing "LIST" - type switching parameter

Functions of keys when editing numeric and switching parameters:



- Selecting the decimal position of the edited numeric parameter. Selected item is distinguished with brackets and flashes. In the case of switching parameters these keys are not used.



- Change of current value (i.e. flashing) of the digit (for numeric parameters) or switching status (for switching parameters, e.g. "**Input type**").



- Confirm the changes and end parameter editing.



- Cancel changes.

7.1.2. Text parameters

Text parameters constitute a series of characters selected from the character table (Fig. 7.7) stored in the unit's memory. Entering the new parameter value (Fig. 7.6, 7.7) consists of selecting consecutive characters of the text by indicating the position of the character in the table displayed below edited text. The edited character is placed in brackets and flashes; its source is indicated in the characters table with brackets surrounding the edited character.

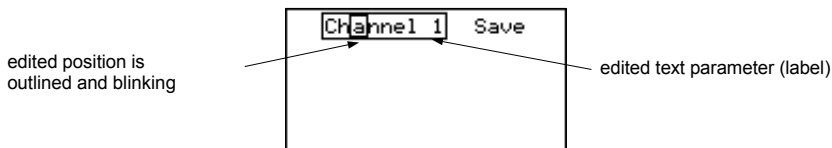

Fig. 7.6. Selection of character for editing

Functions of keys when selecting character for editing (characters table is not displayed at that time):



- Selecting the position of edited character or option of saving text parameter. The selected character (save option) is distinguished with brackets.



- Start editing the character for the selected position
- Confirm the changes and finish parameter editing (when option "Save" is distinguished with brackets and flashes).



- Cancel changes (at any time).

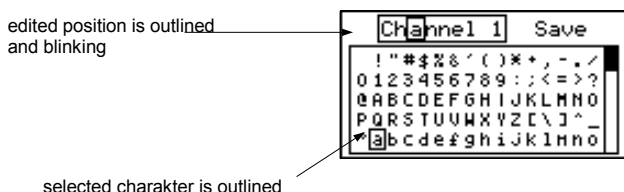

Fig. 7.7. Character editing

Functions of keys when editing selected character

(at this time characters table is displayed below the edited parameter):



- Selecting the character from the given line of characters table for the edited position of the text parameter.



- Selecting the character from the given column of characters table for the edited position of the text parameter.



- Confirm the selected character from characters table for the edited position and start editing next character or completing character editing (if the edited character was the last one in the sequence).



- Cancel changes (at any time).

7.1.3. "SLIDER" - type parameters

The parameters of this type are presented graphically in the form of a bar that turns black correspondingly to the ratio of the current value of the selected parameter to the maximum value of this parameter. Entering the new parameter value (Fig. 7.8) consists of changing the level of "blackening" the bar within the allowable range using the [<], [>] keys.

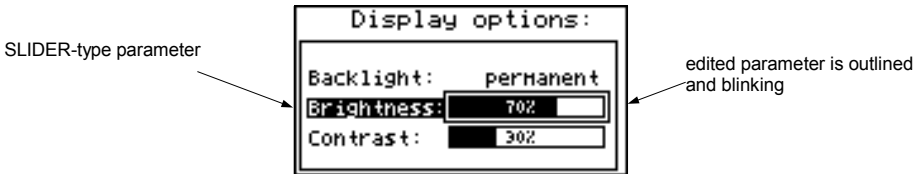

Fig. 7.8. Editing "SLIDER" - type parameter

Functions of keys when editing "SLIDER" - type parameters:



- Change the value of edited parameter. The edited parameter placed in brackets and flashes.



- Finish editing parameter.



- Cancel changes (at any time).

7.2. DESCRIPTION OF RESULTS PRESENTATION MODES MENU

Press the **[ESC/MENU]** key in the current results presentation mode to go to the results presentation mode configuration menu.

7.2.1. "Graph options" menu

This menu contains options configuring the method of displaying measurement results for the "**Graph**" mode:

"Scale" - this option allows time points corresponding to particular points on the horizontal axis of the graph (time axis) to be defined. 16 options are available: from **0.125 seconds/point** to **5 minutes/point**.

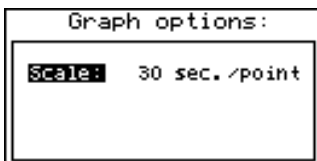

Fig. 7.9. "**Graph options**" menu

7.2.2. "Channels list options" menu

This menu contains options configuring the method of displaying measurement results for the "**Channels list**" mode:

"Display" - this option enables the selection of the method of displaying measurement results. The following possibilities are available:

"values" - measurement results displayed in numeric form

"bar graphs" - measurement results displayed in the form of bars (percentage)

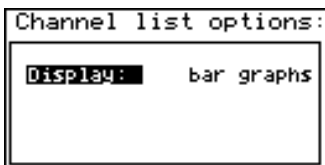
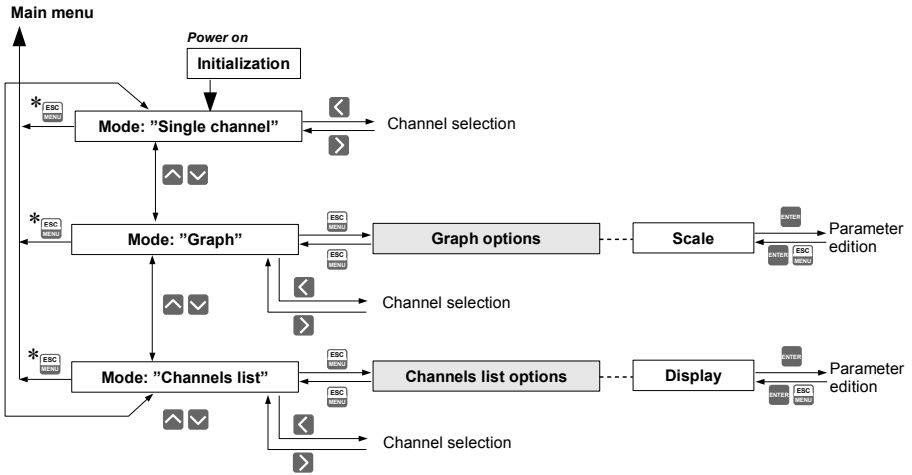

Fig. 7.10. "**Channels list options**" menu

7.3. RESULTS PRESENTATION MODES MENU STRUCTURE



* Press and hold at least 2 seconds

7.4. MAIN MENU DESCRIPTION

7.4.1. "Device information" menu

This menu contains information about the unit and cannot be edited:

- "Version" - version of unit firmware,
- "Serial no" - unit serial number,

7.4.2. "Display options" menu

This menu contains options that enable the displaying parameters of the LCD to be changed:

- "Backlight" - this option allows one to define when the LCD backlight is to be switched on. The following possibilities are available:

- "permanent" - backlight always On,
- "temporary" - backlight is turned on when any key on the unit is pressed and switches Off after 1 minute since the last activation of the keys, and turned on for approximately 10 seconds when the unit is switched on.

- "Brightness" - brightness of display backlight as a percentage

- "Contrast" - contrast of the display as a percentage



If the display backlight is inactive and the "Backlight" option was set as "temporary" pressing any key will **only** switch the backlight on.

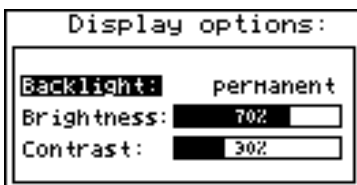

Fig. 7.11. "Display options" menu

7.4.3. "Input settings" menu (common parameters)

This menu enables the configuring of current inputs. The number of the configured input is displayed in the upper part of the display (Fig. 7.12). The following options are available in this menu:

"Name" - name assigned for the given channel (9-character sequence enabling identification of given channel),

"Filter" - this option enables the level of the filtration of indications to be changed. Permissible values: from 0 (no filtration) to 5 (filtration with maximum time constant of approx. 2 seconds).

"AL1 mode" - those parameters describes the way of alarms generation. Each channel is **"AL2 mode"** able to generate two independent alarms, used in control of the outputs (see „Outputs settings“). The following options are available:

"Under threshold" - alarm is generated when displayed value in this channel is under entered value.

"Over threshold" - alarm is generated when displayed value in this channel is over entered value.

"Threshold 1" - the value entered in this field is constantly compared with the current **"Threshold 2"** value. Outpassing this value (up or down, depends on mode setting) causes alarm generation.



Entered values are not checked by the device. If value of the threshold is out range of the current channel (e.g.: -10 when minimal value in the channel is 0) specific alarm will not be generated (or will be generated continuously, depending on „AL1 mode“, „AL2 mode“ settings).

"Hysteresis 1" - the hysteresis values for the **"Threshold 1"** and **"Threshold 2"** parameters. Those parameters can be configured to prevent generation of short and often alarms. When this parameter is set to value greater than 0 the specific alarm is generated when displayed value exceeds threshold +/- hysteresis.

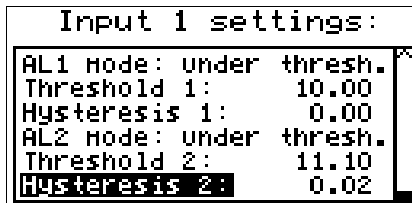

Fig. 7.12. „Input settings“ - alarms settings

7.4.4. "Input settings" menu (SWP-99X)

"Unit" - 4-character sequence constituting the unit for the value measured on the given channel.

"Input type" - type of input/sensor. The following options are available:

"inactive" - input is not active

"0-20 mA", "4-20 mA" - current inputs, displayed value is defined by "Hi value", "Lo value" and "Dec. point" parameters.

"0-5 V", "1-5 V",
"0-10 V", "2-10 V" - voltage inputs, displayed value is defined by "Hi value", "Lo value" and "Dec. point" parameters.

"Hi value" - these parameters define the values displayed for maximum (Hi), and
"Lo value" - minimum (Lo) current (voltage) of **user defined range** (0-20 mA, 4-20 mA, 0-5 V, 1-5 V, 0-10 V, 2-10 V). The aforesaid parameters can be set in the range - 9999 ÷ 9999. A negative number can be input by entering a '-' mark (using [^], [v] keys).

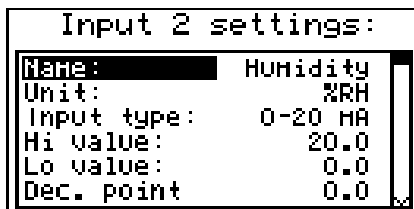

Fig. 7.13. "Inputs settings" (part 1)



The value of the "Lo value" parameter can be higher than the value of "Hi value" parameter. In such a case, for an increasing value of input current (voltage) the displayed value decreases.

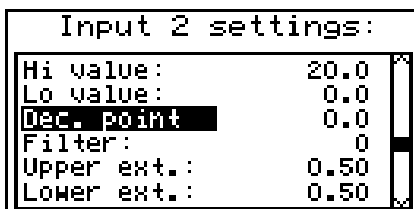

Fig. 7.14. "Inputs settings" menu (part 2)

"Dec. point" - position of the decimal point for results displayed in numerical form.

The following options are available:

- "0"
- "0.0"
- "0.00"
- "0.000"

The position of the decimal point is selected with [^], [v] keys.

"Upper ext." - parameter defining the allowable range of input currents (Fig. 7.13).

"Lower ext." If the input current (voltage) lies within the defined range then the appropriate measurement result shall be displayed despite exceeding the nominal measurement value (0-20 mA, 4-20 mA, 0-5 V, 1-5 V, 0-10 V, 2-10 V). If the input current (voltage) exceeds the range defined by **"Upper extension"**, **"Lower extension"**, a **"-Hi-"** or **"-Lo-"** message (depending on the direction of exceeding the range) shall be displayed instead of the measurement result in numeric form. The **"Upper extension"** and **"Lower extension"** values are defined in mA or V with the accuracy of 0.01 mA or 0.01 V. The **"Lower extension"** value is defined in relation to a 4 mA current, in the range of 0-3.99 mA, 1 V voltage, in the range 0-0.99 V, 2 V, in the range of 0-1.99 V (this parameter is not significant in the "0-20 mA", "0-5 V" and "0-10 V" mode). The **"Upper extension"** value is defined in relation to a 20 mA current in the range of 0-1.99 mA, 5 V voltage in the range 0-0.49 V, 10 V in the range 0-0.99 V.

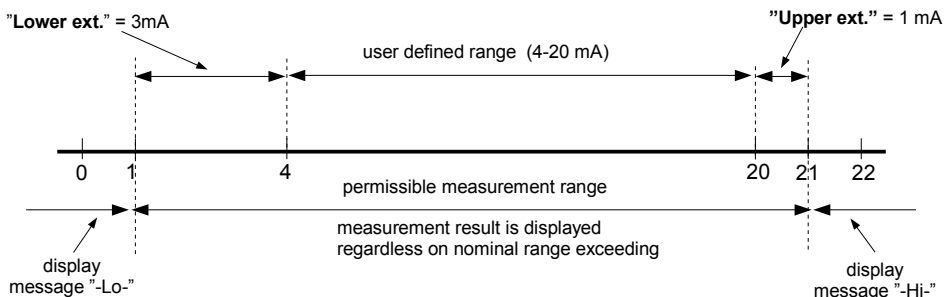

Fig. 7.15. Defining permissible measurement range for an example of settings of **"Upper ext."** and **"Lower ext."** parameters (for user range 4-20 mA)

7.4.5. "Input settings" menu (SWT-99X)

"Unit" - when parameter "Input type" is set on **tc - K**, **tc - S**, **tc - J**, **tc - T**, **tc - N**, **tc - R**, **tc - B**, **tc - E** or **PT100**, **PT500**, **PT1000**, parameter "Unit" allows to change present unit. Two types of the scale are available: Fahrenheit and Celsius. When parameter "Input type" is set on **60 mV**, **75 mV**, **100 mV**, **150 mV**, parameter "Unit" provides 4-character sequence constituting the unit for the value measured on the given channel.

"Input type" - type of input/sensor. The following options are available:

"inactive" - input is not active

"60 mV" - millivoltage inputs, *user defined range* is defined by "Hi value", "Lo value" parameters.

"75 mV"

"100 mV"

"150 mV"

"PT100" - temperature sensor inputs, *user defined range* is defined by "Hi value" and "Lo value" parameters.

"PT500"

"PT1000"

"tc - K" - thermocouple sensor inputs, *user defined range* is defined by "Hi value" and "Lo value" parameters.

"tc - S"

"tc - J"

"tc - T"

"tc - N"

"tc - R"

"tc - B"

"tc - E"

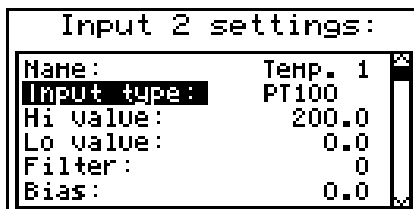

Fig. 7.16. "Inputs settings"



"Input type" parameter settings affects on occurrence of parameters described below.

“Connection” - This parameter is available only when **“Input type”** is set as **RTD input**. This parameter specifies how many wires will be used during measurement.

“Hi value”
“Lo value” - These parameters define lower and upper limits of **user defined range**. The percentage results and the graph are scaled due to this range. The aforesaid parameters can be set in the range $-9999 \div 9999$ with a dot anywhere. A negative number can be input by entering a **‘-’** mark (using **[^]**, **[v]** keys).

i The value of the **“Lo value”** parameter can be higher than the value of **“Hi value”** parameter. In such a case, the device automatically selects lower value as lower limit, and higher value as upper limit of **user defined range**.

“Dec. point” - position of the decimal point for results displayed in numerical form. The following options are available:
“0”
“0.0”
“0.00”
“0.000”

The position of the decimal point is selected with **[^]**, **[v]** keys.

“Upper ext.” - These parameters are available only if **“Input type”** is set on **mV input**.

“Lower ext.” Parameter defining the allowable range of input currents (**Fig. 7.14**). If the input voltage lies within the defined range then the appropriate measurement result shall be displayed despite exceeding the nominal measurement value (0-60 mV, 0-75 mV, 0-100 mV, 0-150 mV). If the input voltage exceeds the range defined by **“Upper extension”**, **“Lower extension”**, a **“-Hi-”** or **“-Lo-”** message (depending on the direction of exceeding the range) shall be displayed instead of the measurement result in numeric form. The **“Upper extension”** value is defined in mV with the accuracy of 0.01 mV. The **“Upper extension”** value is defined in relation to a 60 mV voltage in the range of 0-5.99 mV, 75 mV voltage in the range 0-7.49 mV, 100 mV in the range 0-9.99 mV, 150 mV voltage in the range 0-14.99 mV.

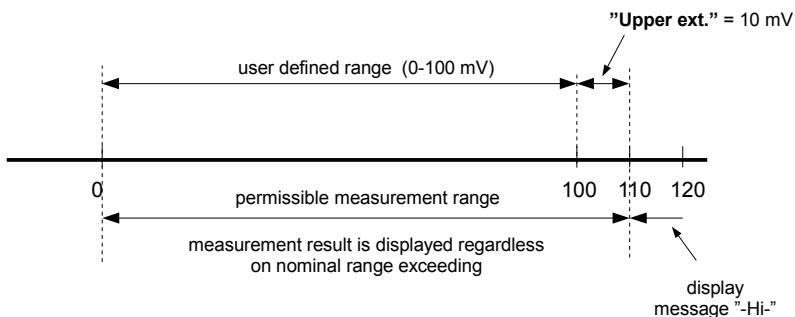

Fig. 7.17. Defining permissible measurement range for an example of settings of **“Upper ext.”** parameter (for range 0-100 mV)

"Bias" - parameter (expressed in °C or °F) which allows to shift measurement scale and express value added to displayed result in range ± 299 °C (± 299 °F) for TC type inputs or in range ± 29.9 °C (± 29.9 °F) for RTD type inputs.

7.4.6. "Outputs settings" menu

This menu allows to change settings of the outputs.

"Mode" - Defines operation mode of the output. The following options are available:

- "inactive"** - output is always OPEN. State of the attached channels alarms are ignored,
- "N.O."** - normally OPEN,
- "N.C."** - normally CLOSED.

"Logic funct." - describes active-state computing method for attached alarms. The following options are available:

- „OR"** - output is active when **any** of the attached channels is alarm state.
- „AND"** - output is active when **all** of the attached channels are in alarm state.

"Source" - brings up a submenu with alarm sources settings (**Fig. 7.18**). The following options are available for each channel:

- "inactive"** - channel is ignored (never in alarm state).
- "alarm 1"** - channel is in alarm state when alarm 1 is generated.
- "alarm 2"** - channel is in alarm state when alarm 2 is generated.
- "alarm 1 or 2"** - channel is in alarm state when alarm 1 or alarm 2 are generated.
- "alarm 1 and 2"** - channel is in alarm state when alarm 1 and alarm 2 are generated in the same time.

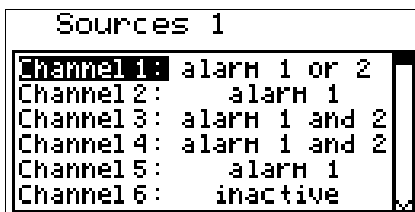

Fig. 7.18. Submenu "Source" in menu „Outputs settings”.

"Close delay" - Output switch from open to closed state will be delayed until this time elapse.

"Open delay" - Output switch from closed to open state will be delayed until this time elapse.



If condition to switch state of the output will repeat occurring more often than half of the delay and mean duty cycle (\bar{D}) will be greater than 50% the output will eventually switch. See chapter "Outputs control" for more details.

"Closed hold time" - a relay active state maintain time after the triggering signal disappears,

"Open hold time" - a relay inactive state maintain time after the triggering signal disappears,



- All time type parameters which describe outputs, can be set in range 0 ÷ 9999 with resolution of 1 sec.
- Because of computing precision, the time is shorter about 2.5% than the entered value. This means if time is set to 100.0s the real time will be shorter about 2.5s.

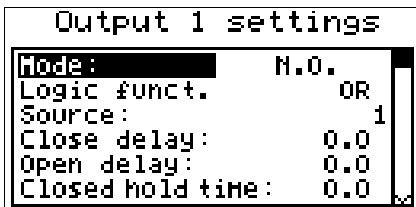

Fig. 7.19. "Outputs settings" menu.

7.4.7. "Date & time settings" menu

Menu allows to change date and time of internal clock (RTC):

"Time" - current time according to the unit's real time clock,

"Date" - current date according to the unit's real time clock,

"Apply" - this option enables the internal real time clock to be set according to values of the **"Time"** and **"Date"** parameters.

After entering the menu the current indications of the internal clock are displayed. The changing of parameters (**"Time"** or **"Date"**) stops the indications updating. Changed parameters must be stored using the **"Apply"** option.

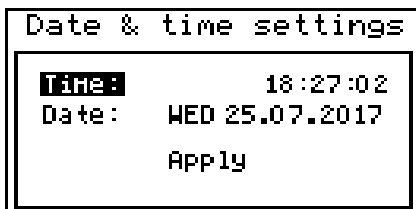

Fig. 7.20. "Date & time settings" menu

7.4.8. "RS485 port settings" menu

This menu contains options to configure the RS-485 interface:

"Address" - this parameter specifies the unit's address, according to the Modbus protocol (in the range of 0 to 99). If the address is set as 0, then the unit responds to the FFh address.

"Baud rate" - this option defines the RS-485 serial interface transmission speed. 8 possibilities are available:
"1200", "2400", "4800", "9600", "19200", "38400", "57600", "115200" b/sec.

i Default baud rate value is 115200 b/sec. Some RS-485 converters may not work properly with this setting. In such a case set lower baud rate (according to converter data sheet).

"Resp. delay" - this parameter defines minimal (additional) delay between the Modbus message and the answer of the device (received and sent via RS-485 interface). This additional delay allows the device to work with poor RS-converters which do not works properly on baud rates higher than 19200. This parameter can be set to one of values:

"stand." - device responds without any additional delay
" +10 ch."
" +20 ch."
" +50 ch."
" +100 ch."
" +200 ch."

} The unit response with additional delay equal to transmission time of 10, 20, 50, 100 or 200 characters.

i In the most cases parameter **"Response delay"** should be set to **"Stand."** (no additional delay). Unfortunately for some third party RS-converters **"Response delay"** should be adjusted experimentally. Table below contains most frequently used values.

"Baud rate" parameter	"38400"	"57600"	"115200"
"Resp. delay" parameter	" +10 ch."	" +20 ch."	" +50 ch."

Tab. 7.1. Settings of **"Resp. delay"** parameter

"Conf. change" - this option allows the method of accessing unit's configuration registers through the RS-485 interface to be defined. The following options are available:

"denied" - configuration registers can not be set via RS-485 interface,
"allowed" - configuration registers can be set via RS-485 interface.

```

RS485 port settings:
Address:          1
Baud rate: 115200 b/sec.
Resp.delay: stand.
Conf.change: allowed
    
```

Fig. 7.21. **"RS485 port settings"** menu

7.4.9. "Access setup" menu

This menu contains options controlling access to the unit's adjustable parameters:

"Password for menu access" - menu access password (4-digit number). If the parameter is set to **"0000"** the password is disabled. If the parameter is different from **"0000"** then menu access requires password to be entered.

If the user do not remember his password, the access to the menu is possible by the **"one-use password"**. To get this password please contact with Marketing Division. Please set new user password immediately after use of the **"one-use password"**.

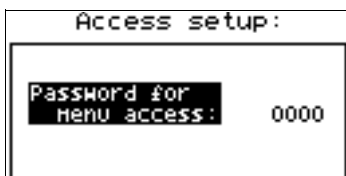

Fig. 7.22. "Access setup" menu

7.4.10. "Language" parameter

This parameter allows selection of messages and menu language.

7.4.11. "Default settings" parameter

This parameter allows to restore the default settings of the device. In order to get the access to this option special password is required "5465", next the device will display acknowledge question **"Are you sure"**. Choosing the answer **"YES"** and confirming it by **[ENTER]** will restore the default settings of the device.

7.5. MAIN MENU STRUCTURE

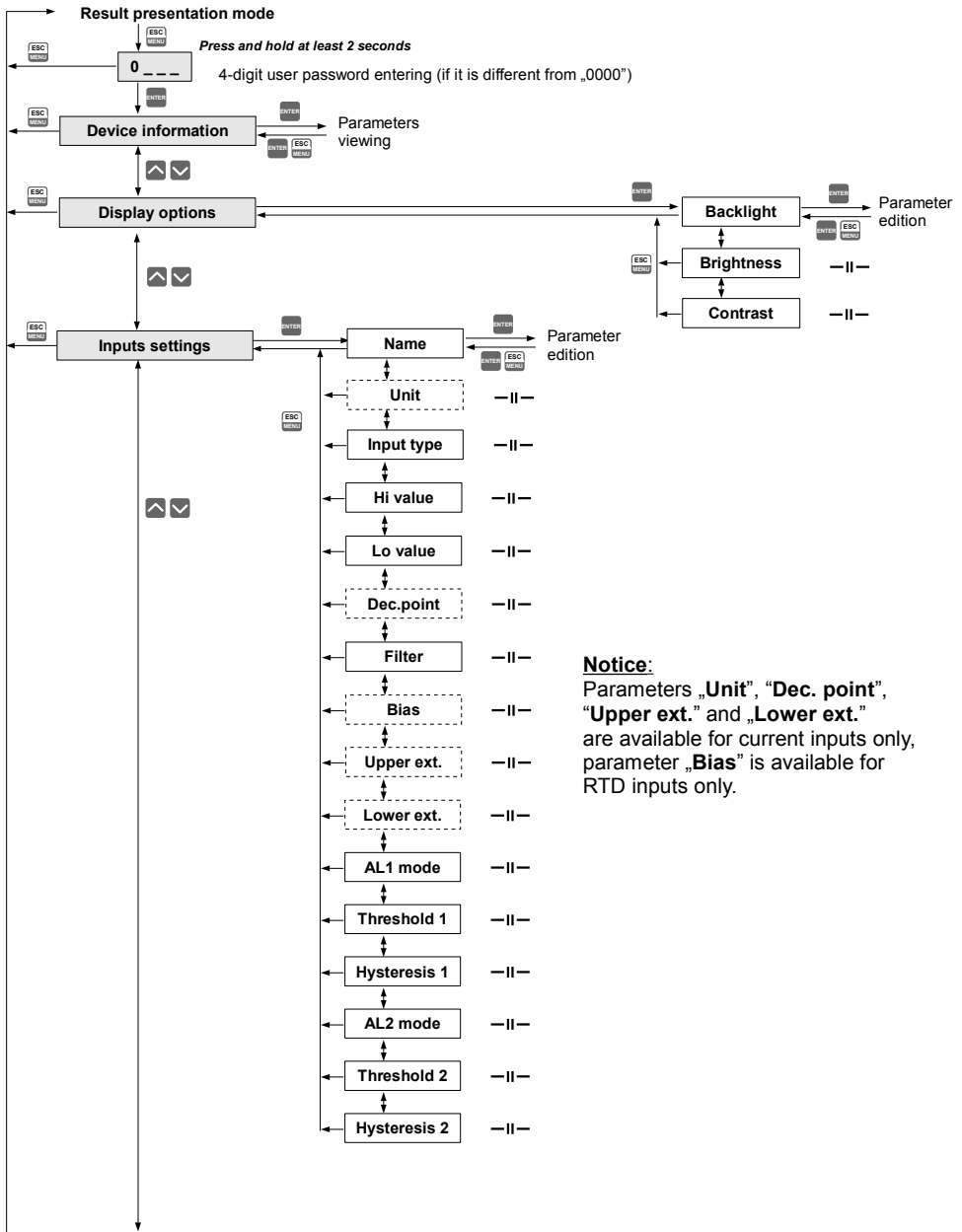

Notice:
Parameters „Unit”, „Dec. point”, „Upper ext.” and „Lower ext.” are available for current inputs only, parameter „Bias” is available for RTD inputs only.

See next page

See previous page

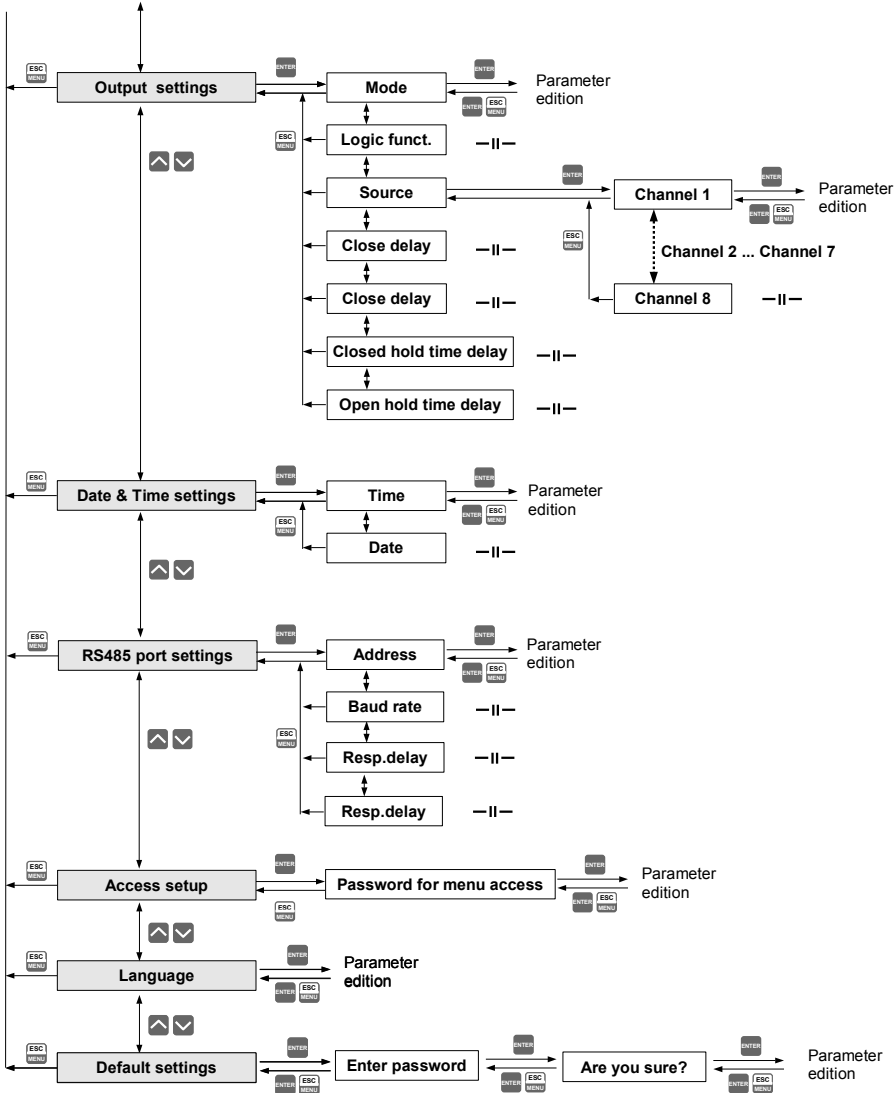

8. THE MODBUS PROTOCOL HANDLING

Transmission parameters: 1 start bit, 8 data bits, 1 stop bit, no parity control
 Baud rate: selectable from: 1200 to 115200 bits/second
 Transmission protocol: MODBUS RTU compatible

The device parameters and measurement result are available via RS-485 interface, as HOLDING-type registers of Modbus RTU protocol. The registers (or groups of the registers) can be read by 03h function, and wrote by 06h (single registers) or 10h (group of the registers) accordingly to Modbus RTU specification.

8.1. LIST OF REGISTERS

Register	Write	Range	Register description
01h ¹	No	see descr.	Measurement result for channel 1 (not considering the decimal point) Current and voltage inputs version range: -9999+9999 RTD inputs version range: -1000 ÷ 6000 (for °C)
Register from 02h ¹ to 08h ¹			Measurement result for channel 2..8, registry description like for channel 1 (see registers 01h).
09h	No	0÷0FFFFh	Information about exceeding the allowable measurement range on the given measurement channel in binary form: HGFEDCBAhgfedcba . Higher(2nd) byte - exceeding upper limit of measurement range (H - channel no 8, A - channel no 1). Lower(1st) byte - exceeding upper limit of measurement range (h - channel no 8, a - channel no 1). 1 - exceeding the range, 0 - measurement result within range
0Bh	No	0÷3	Outputs state (binary) 00000000 000000ba : a – output 1 b – output 2 0 – open; 1 – closed
0Ch	No	-40 ÷ 100	Outer temperature measurement result (in °C)
11h	Yes	0÷1	"Backlight" parameter in "Display options" menu: 0 - permanent, 1 - temporary
12h	Yes	0÷20	LCD backlight brightness
13h	Yes	0÷20	LCD contrast
14h	Yes	0÷3	"Language" parameter: 0 - Polish, 1 - English, 2 - French, 3 - Spanish
18h	No	0÷6	Days of the week registry
19h	Yes	2000÷2099	Year registry
1Ah	Yes	1÷12	Months registry
1Bh	Yes	1÷31	Days registry
1Ch	Yes	0÷23	Hours registry
1Dh	Yes	0÷59	Minutes registry
1Eh	Yes	0÷59	Seconds registry

Register	Write	Range	Register description
1Fh	Yes	0÷3	Control registry for time-related settings: 0 - starting continuous updating of registries 18h ÷ 1Eh by the internal clock (current time and date), 80h - stopping continuous updating of registries 18h ÷ 1Eh by the internal clock (automatically after writing one of 18h ÷ 1Eh registries). In this status 18h ÷ 1Eh registries can be written with new values in order to update internal clock settings. Updating the clock settings with contents of 18h ÷ 1Eh registries can be executed by sending the following commands to the control registry: 1 - hour update on the basis of (1Ch ÷ 1Eh) registries' contents; 2 - date update on the basis of (18h ÷ 1Bh) registries' contents; 3 - time and date update on the basis of (18h ÷ 1Eh) registries' contents. After sending commands 1 , 2 or 3 the contents of registries automatically return to 0.
20h ²	Yes	0÷199	Address of device
21h	No	see descr.	Device identification code Voltage-current inputs version: 5Dh TC/RTD inputs version: 67h
22h ³	Yes	0÷7	" Baud rate " parameter in " RS485 port settings " menu (baud rate): 0 - 1200; 1 - 2400; 2 - 4800; 3 - 9600; 4 - 19200; 5 - 38400; 6 - 57600; 7 - 115200;
23h ⁴	Yes	0÷1	" Conf. change " parameter in " RS485 port settings " menu (permission to write registers): 0 - write denied; 1 - write allowed.
28h	No		Firmware version
29h	No		Compilation number
2Ah	No		Higher (2 nd) word of serial number
2Bh	No		Lower (1 st) word of serial number
2Ch	No	1, 4, 8	Number of units' measurement channels
Configuration parameters for channel No. 1 (SWP-99X)			
40h	Yes	0÷6	" Input type " parameter in " Inputs settings " submenu for channel 1: 0 - inactive; 1 - 0-20 mA; 2 - 4-20 mA; 3 - 0-5 V; 4 - 1-5 V; 5 - 0-10 V; 6 - 2-10 V
41h	Yes	-9999÷9999	" Lo value " parameter in " Inputs settings " submenu for channel 1 (not considering decimal point)
42h	Yes	-9999÷9999	" Hi value " parameter in " Inputs settings " submenu for channel 1 (not considering decimal point)
43h	Yes	0÷3	" Dec. point " parameter in " Inputs settings " submenu for channel 1: 0 - 0; 1 - 0,0; 2 - 0,00; 3 - 0,000
44h	Yes	0÷5	" Filter " parameter in " Inputs settings " submenu for channel 1: (filtration coefficient)
45h	Yes	0÷399	" Lower ext. " parameter in " Inputs settings " submenu for channel 1 expressed in 0.01 mA (not considering decimal point)

Register	Write	Range	Register description
46h	Yes	0÷199	“Upper ext.” parameter in “Inputs settings” submenu for channel 1 expressed in 0.01 mA (not considering decimal point)
Configuration parameters for channel No. 1 (SWT-99X)			
40h	Yes	0÷15	“Input type” parameter in “Inputs settings” submenu for channel 1: 0 - inactive; 1 – 60 mV; 2 - 75 mV; 3 – 100 mV; 4 – 150 mV; 5 – PT100; 6 – PT500; 7 – PT1000; 8 – Tc – K; 9 – Tc – S; 10 – Tc – J; 11 – Tc – T; 12 – Tc – N; 13 – Tc – R; 14 – Tc – B; 15 – Tc – E
41h	Yes	-9999÷9999	“Lo value” parameter in “Inputs settings” submenu for channel 1 expressed by 0,1°C or °F (not considering decimal point)
42h	Yes	-9999÷9999	“Hi value” parameter in “Inputs settings” submenu for channel 1 expressed by 0,1°C or °F (not considering decimal point)
43h	No	1	“Dec. point” parameter in “Inputs settings” submenu for channel 1, constant value: 1-0.0
44h	Yes	0÷5	“Filter” parameter in “Inputs settings” submenu for channel 1: (filtration coefficient)
45h	Yes	-99÷99	“Bias” parameter in “Inputs settings” submenu for channel 1 expressed in 0,1°C (not considering decimal point)
Configuration parameters for channel No. 1 (common)			
47h	Yes	Character	“Name” parameter in “Inputs settings” submenu for channel 1; Higher byte – character No. 1; Lower byte – character No. 2
48h	Yes	Character	“Name” parameter in “Inputs settings” submenu for channel 1; Higher byte – character No. 3; Lower byte – character No. 4
49h	Yes	Character	“Name” parameter in “Inputs settings” submenu for channel 1; Higher byte – character No. 5; Lower byte – character No. 6
4Ah	Yes	Character	“Name” parameter in “Inputs settings” submenu for channel 1; Higher byte – character No. 7; Lower byte – character No. 8
4Bh	Yes	Character	“Name” parameter in “Inputs settings” submenu for channel 1; Higher byte – character No. 9; Lower byte – 0
4Ch	Yes	Character	“Unit” parameter in “Inputs settings” submenu for channel 1; Higher byte – character No. 1; Lower byte – character No. 2
4Dh	Yes	Character	“Unit” parameter in “Inputs settings” submenu for channel 1; Higher byte – character No. 3; Lower byte – character No. 4
Register from 50h to 5Fh and 150h			Parameters in “Inputs settings” submenu for channel 2; registry description like for channel 1 (see registers 40h to 4Fh and 140h).
Register from 60h to 6Fh and 160h			Parameters in “Inputs settings” submenu for channel 3; registry description like for channel 1 (see registers 40h to 4Fh and 140h).
Register from 70h to 7Fh and 170h			Parameters in “Inputs settings” submenu for channel 4; registry description like for channel 1 (see registers 40h to 4Fh and 140h).
Register from 80h to 8Fh and 180h			Parameters in “Inputs settings” submenu for channel 5; registry description like for channel 1 (see registers 40h to 4Fh and 140h).
Register from 90h to 9Fh and 190h			Parameters in “Inputs settings” submenu for channel 6; registry description like for channel 1 (see registers 40h to 4Fh and 140h).

Register	Write	Range	Register description
Register from A0h to AFh and 1A0h			Parameters in "Inputs settings" submenu for channel 7; registry description like for channel 1 (see registers 40h to 4Fh and 140h).
Register from B0h to BFh and 1B0h			Parameters in "Inputs settings" submenu for channel 8; registry description like for channel 1 (see registers 40h to 4Fh and 140h).
Alarm configuration parameters for channel No. 1			
C0h	Yes	0÷1	"AL1 mode" parameter in "Inputs settings" submenu for channel 1; 0 – under threshold; 1 – over threshold
C1h	Yes	-9999÷9999	"Threshold 1" parameter in "Inputs settings" submenu for channel 1;
C2h	Yes	-9999÷9999	"Hysteresis 1" parameter in "Inputs settings" submenu for channel 1;
C3h	Yes	0÷1	"AL2 mode" parameter in "Inputs settings" submenu for channel 1; 0 – under threshold; 1 – over threshold
C4h	Yes	-9999÷9999	"Threshold 2" parameter in "Inputs settings" submenu for channel 1;
C5h	Yes	-9999÷9999	"Hysteresis 2" parameter in "Inputs settings" submenu for channel 1;
Register from C8h to CDh			Alarm parameters in "Inputs settings" submenu for channel 2; registry description like for channel 1 (see registers C0h to C5h).
Register from D0h to D5h			Alarm parameters in "Inputs settings" submenu for channel 3; registry description like for channel 1 (see registers C0h to C5h).
Register from D8h to DDh			Alarm parameters in "Inputs settings" submenu for channel 4; registry description like for channel 1 (see registers C0h to C5h).
Register from E0h to E5h			Alarm parameters in "Inputs settings" submenu for channel 5; registry description like for channel 1 (see registers C0h to C5h).
Register from E8h to EDh			Alarm parameters in "Inputs settings" submenu for channel 6; registry description like for channel 1 (see registers C0h to C5h).
Register from F0h to F5h			Alarm parameters in "Inputs settings" submenu for channel 7; registry description like for channel 1 (see registers C0h to C5h).
Register from F8h to FDh			Alarm parameters in "Inputs settings" submenu for channel 8; registry description like for channel 1 (see registers C0h to C5h).
Configuration parameters for output No. 1			
100h	Yes	0÷2	"Mode" parameter in "Outputs settings" submenu for output 1; 0 – inactive (always OPEN) 1 – normally OPEN (N.O.) 2 – normally CLOSED (N.C.)
101h	Yes	0÷1	"Logic func." parameter in "Outputs settings" submenu for output 1; 0 – OR; 1 – AND

Register	Write	Range	Register description
102h	Yes	0÷4	“ Channel 1 ” parameter in “ Outputs settings:source ” submenu for output 1; 0 – inactive 1 – alarm 1 2 – alarm 2 3 – alarm 1 or 2 4 – alarm 1 and 2
103h	Yes	0÷4	“ Channel 2 ” parameter in “ Outputs settings:source ” submenu for output 1; registry description like for “ Channel 1 ” (see register 102h).
104	Yes	0÷4	“ Channel 3 ” parameter in “ Outputs settings:source ” submenu for output 1; registry description like for “ Channel 1 ” (see register 102h).
105	Yes	0÷4	“ Channel 4 ” parameter in “ Outputs settings:source ” submenu for output 1; registry description like for “ Channel 1 ” (see register 102h).
106	Yes	0÷4	“ Channel 5 ” parameter in “ Outputs settings:source ” submenu for output 1; registry description like for “ Channel 1 ” (see register 102h).
107	Yes	0÷4	“ Channel 6 ” parameter in “ Outputs settings:source ” submenu for output 1; registry description like for “ Channel 1 ” (see register 102h).
108	Yes	0÷4	“ Channel 7 ” parameter in “ Outputs settings:source ” submenu for output 1; registry description like for “ Channel 1 ” (see register 102h).
109	Yes	0÷4	“ Channel 8 ” parameter in “ Outputs settings:source ” submenu for output 1; registry description like for “ Channel 1 ” (see register 102h).
10A	Yes	0÷9999	“ Close delay ” parameter in “ Outputs settings ” submenu for output 1
10B	Yes	0÷9999	“ Open delay ” parameter in “ Outputs settings ” submenu output 1
10C	Yes	0÷9999	“ Closed hold time ” parameter in “ Outputs settings ” submenu for output 1.
10D	Yes	0÷9999	“ Open hold time ” parameter in “ Outputs settings ” submenu for output 1.
Register from 110h to 11Dh			Parameters in “ Outputs settings ” submenu for output 2; registry description like for output 1 (see registers 100h to 10Dh).

- 1 - if the measurement result exceeds the allowable measurement range defined by “**Hi value**”, “**Lo value**” parameters then 01h ÷ 08h registries shall contain limit values for the allowable range. Exceeding the allowable measurement range shall be signalled by setting appropriate bits of the 09h registry.
- 2 - after writing registry 20h the unit replies with the frame starting from the old (unchanged) address
- 3 - after writing registry 22h the unit replies with the frame sent according to the new baud rate
- 4 - status of “**Triggering**” parameter in “**RS485 port settings**” submenu also relates to the writing of this parameter; therefore it is possible to block writing of all registries using the RS-485 port, but unblocking can be made only through the device's menu.

8.2. TRANSMISSION ERRORS HANDLING

If during reading or writing one of registries an error occurs then the unit shall return the frame containing the error code (according to the Modbus protocol, see: example No. 5, page 59).

Error codes should be interpreted as follows:

01h - illegal function (only functions 03h, 06h and 10h are available),

02h - illegal register address

03h - illegal data value

08h - no write permission (see: “**Config change**” parameter in the “**RS485 port settings**” menu)

8.3. EXAMPLES OF QUERY/ANSWER FRAMES

The examples concern a unit with address 1. All values are given in the hexadecimal system.

Designations:

ADDR Address of the device in the system

FUNC Function number

REG H,L Higher and lower part of registry number, to which the command refers to

COUNT H,L Higher and lower part of registry counter number, to which the command refers to, starting with the register, which is defined by REG (max. 32)

BYTE C Number of higher bytes in the frame

DATA H,L Higher and lower part of data word

CRC L,H Higher and lower part of CRC sum

1. Read of ID code

ADDR	FUNC	REG H,L		COUNT H,L		CRC L,H	
01	03	00	21	00	01	D4	00

The answer:

ADDR	FUNC	BYTE C	DATA H,L		CRC L,H	
01	03	02	00	52	80	4D

DATA H,L - identification code (0052h)

2. Change of the device address from 1 to 2 (write to reg. 20h)

ADDR	FUNC	REG H,L		DATA H,L		CRC L,H	
01	06	00	20	00	02	09	C1

DATA H - 0

DATA L - new device address (2)

The answer (the same as the message):

ADDR	FUNC	REG H,L		DATA H,L		CRC L,H	
01	06	00	20	00	02	09	C1

3. Read of the displayed value (measurement) for channel 1, the device address = 01h:

ADDR	FUNC	REG H,L		COUNT H,L		CRC L,H	
01	03	00	01	00	01	D5	CA

The answer:

ADDR	FUNC	BYTE C	DATA H,L		CRC L,H	
01	03	02	00	FF	F8	04

DATA H, L - displayed value = 255, no decimal point. Decimal point position can be read from reg. 43h (position of decimal point for channel 1)

4. Read of the registers 1, 2 and 3 in one message (example of reading a number of registries in one frame):

ADDR	FUNC	REG H,L		COUNT H,L		CRC L,H	
01	03	00	01	00	03	54	0B

COUNT L - the count of being read registers (max. 32)

The answer:

ADDR	FUNC	BYTE C	DATA H1,L1		DATA H2,L2		DATA H3,L3		CRC L,H	
01	03	06	00	0A	00	02	02	80	18	74

DATA H1, L1 - 01h registry (10 – value displayed for channel 1, no decimal point),
 DATA H2, L2 - 02h registry (2 – value displayed for channel 2, no decimal point),
 DATA H3, L3 - 03h registry (640 – value displayed for channel 3, no decimal point).

**5. Setting of name for channel 1 as "Channel 1 "
 (example of writing a number of registries in one frame)**

ADDR	FUNC	REG H,L		COUNT H,L		BYTE C
01	10	00	47	00	05	0A

continue of frame:

DATA H1,L1		DATA H2,L2		DATA H3,L3		DATA H4,L4		DATA H5,L5		CRC L,H	
43	68	61	6E	6E	65	6C	20	31	20	7F	D0

DATA H1, L1 - 47h registry (43h - character "C", 68h - character "h"),
 DATA H2, L2 - 48h registry (61h - character "a", 6Eh - character "n"),
 DATA H3, L3 - 49h registry (6Eh - character "n", 65h - character "e"),
 DATA H4, L4 - 4Ah registry (6Ch - character "l", 20h - space " "),
 DATA H5, L5 - 4Ah registry (31h - character "1", 20h - space " ").

a) The answer (we assume that input current is not out of range):

ADDR	FUNC	REG H,L		COUNT H,L		CRC L,H	
01	10	00	47	00	05	B0	1F

b) The answer (if an error occur):

ADDR	FUNC	ERR	CRC L,H	
01	90	08	4D	C6

ERR - error code (08 - registry writing blocked by "Config change" parameter in "RS485 port settings" menu)

6. Change of baud rate of all devices connected to the net (BROADCAST message).

ADDR	FUNC	REG H,L		COUNT H,L		CRC L,H	
00	06	00	22	00	04	29	D2

DATA H - 0
 DATA L - 4, new baud rate 19200 baud

Device do not reply to BROADCAST-type messages.



There is no full implementation of the Modbus Protocol in the device. The functions presented above are available only.

9. USER'S SETTINGS LIST

Parameter	Description	Value	Description page
Parameters in the "Graph options" menu			
Scale	Setting time scale		39
Parameters in the "Channels list options" menu			
Display	Method of displaying results		39
Parameters in the "Device information" menu			
Version	Device firmware version		41
Serial no	Device serial number		41
Parameters in the "Display options" menu			
Backlight	Method of display backlight operation		41
Brightness	Brightness of display backlight		41
Contrast	Display contrast		41
Settings for Channel 1 in "Inputs settings" menu			
Name	Measurement channel name		42
Unit	Unit for measured value		43
Input type	Type of input/sensor		43, 45
Hi value	Value displayed for maximum value of input current		43, 46
Lo value	Value displayed for minimum value of input current		43, 46
Dec. point	Position of the decimal point		44
Filter	Level of filtration of indications		42
Bias	Shifting of measurement scale		47
Upper ext.	Upper extension of measurement range		44
Lower ext.	Lower extension of measurement range		44
AL1 mode	Alarm 1 generation mode		42
Threshold 1	Threshold of alarm 1		42
Hysteresis 1	Hysteresis of alarm 1		42
AL2 mode	Alarm 2 generation mode		42
Threshold 2	Threshold of alarm 2		42
Hysteresis 2	Hysteresis of alarm 2		42
Settings for Channel 2 in "Inputs settings" menu			
Name	Measurement channel name		42

Parameter	Description	Value	Description page
Unit	Unit for measured value		43
Input type	Type of input/sensor		43, 45
Hi value	Value displayed for maximum value of input current		43, 46
Lo value	Value displayed for minimum value of input current		43, 46
Dec. point	Position of the decimal point		44
Filter	Level of filtration of indications		42
Bias	Shifting of measurement scale		47
Upper ext.	Upper extension of measurement range		44
Lower ext.	Lower extension of measurement range		44
AL1 mode	Alarm 1 generation mode		42
Threshold 1	Threshold of alarm 1		42
Hysteresis 1	Hysteresis of alarm 1		42
AL2 mode	Alarm 2 generation mode		42
Threshold 2	Threshold of alarm 2		42
Hysteresis 2	Hysteresis of alarm 2		42
Settings for Channel 3 in "Inputs settings" menu			
Name	Measurement channel name		42
Unit	Unit for measured value		43
Input type	Type of input/sensor		43, 45
Hi value	Value displayed for maximum value of input current		43, 46
Lo value	Value displayed for minimum value of input current		43, 46
Dec. point	Position of the decimal point		44
Filter	Level of filtration of indications		42
Bias	Shifting of measurement scale		47
Upper ext.	Upper extension of measurement range		44
Lower ext.	Lower extension of measurement range		44
AL1 mode	Alarm 1 generation mode		42
Threshold 1	Threshold of alarm 1		42
Hysteresis 1	Hysteresis of alarm 1		42
AL2 mode	Alarm 2 generation mode		42
Threshold 2	Threshold of alarm 2		42

Parameter	Description	Value	Description page
Hysteresis 2	Hysteresis of alarm 2		42
Settings for Channel 4 in “Inputs settings” menu			
Name	Measurement channel name		42
Unit	Unit for measured value		43
Input type	Type of input/sensor		43, 45
Hi value	Value displayed for maximum value of input current		43, 46
Lo value	Value displayed for minimum value of input current		43, 46
Dec. point	Position of the decimal point		44
Filter	Level of filtration of indications		42
Bias	Shifting of measurement scale		47
Upper ext.	Upper extension of measurement range		44
Lower ext.	Lower extension of measurement range		44
AL1 mode	Alarm 1 generation mode		42
Threshold 1	Threshold of alarm 1		42
Hysteresis 1	Hysteresis of alarm 1		42
AL2 mode	Alarm 2 generation mode		42
Threshold 2	Threshold of alarm 2		42
Hysteresis 2	Hysteresis of alarm 2		42
Settings for Channel 5 in “Inputs settings” menu			
Name	Measurement channel name		42
Unit	Unit for measured value		43
Input type	Type of input/sensor		43, 45
Hi value	Value displayed for maximum value of input current		43, 46
Lo value	Value displayed for minimum value of input current		43, 46
Dec. point	Position of the decimal point		44
Filter	Level of filtration of indications		42
Bias	Shifting of measurement scale		47
Upper ext.	Upper extension of measurement range		44
Lower ext.	Lower extension of measurement range		44
AL1 mode	Alarm 1 generation mode		42
Threshold 1	Threshold of alarm 1		42

Parameter	Description	Value	Description page
Hysteresis 1	Hysteresis of alarm 1		42
AL2 mode	Alarm 2 generation mode		42
Threshold 2	Threshold of alarm 2		42
Hysteresis 2	Hysteresis of alarm 2		42
Settings for Channel 6 in "Inputs settings" menu			
Name	Measurement channel name		42
Unit	Unit for measured value		43
Input type	Type of input/sensor		43, 45
Hi value	Value displayed for maximum value of input current		43, 46
Lo value	Value displayed for minimum value of input current		43, 46
Dec. point	Position of the decimal point		44
Filter	Level of filtration of indications		42
Bias	Shifting of measurement scale		47
Upper ext.	Upper extension of measurement range		44
Lower ext.	Lower extension of measurement range		44
AL1 mode	Alarm 1 generation mode		42
Threshold 1	Threshold of alarm 1		42
Hysteresis 1	Hysteresis of alarm 1		42
AL2 mode	Alarm 2 generation mode		42
Threshold 2	Threshold of alarm 2		42
Hysteresis 2	Hysteresis of alarm 2		42
Settings for Channel 7 in "Inputs settings" menu			
Name	Measurement channel name		42
Unit	Unit for measured value		43
Input type	Type of input/sensor		43, 45
Hi value	Value displayed for maximum value of input current		43, 46
Lo value	Value displayed for minimum value of input current		43, 46
Dec. point	Position of the decimal point		44
Filter	Level of filtration of indications		42
Bias	Shifting of measurement scale		47
Upper ext.	Upper extension of measurement range		44

Parameter	Description	Value	Description page
Lower ext.	Lower extension of measurement range		44
AL1 mode	Alarm 1 generation mode		42
Threshold 1	Threshold of alarm 1		42
Hysteresis 1	Hysteresis of alarm 1		42
AL2 mode	Alarm 2 generation mode		42
Threshold 2	Threshold of alarm 2		42
Hysteresis 2	Hysteresis of alarm 2		42
Settings for Channel 8 in "Inputs settings" menu			
Name	Measurement channel name		42
Unit	Unit for measured value		43
Input type	Type of input/sensor		43, 45
Hi value	Value displayed for maximum value of input current		43, 46
Lo value	Value displayed for minimum value of input current		43, 46
Dec. point	Position of the decimal point		44
Filter	Level of filtration of indications		42
Bias	Shifting of measurement scale		47
Upper ext.	Upper extension of measurement range		44
Lower ext.	Lower extension of measurement range		44
AL1 mode	Alarm 1 generation mode		42
Threshold 1	Threshold of alarm 1		42
Hysteresis 1	Hysteresis of alarm 1		42
AL2 mode	Alarm 2 generation mode		42
Threshold 2	Threshold of alarm 2		42
Hysteresis 2	Hysteresis of alarm 2		42
Output 1 settings in submenu "Outputs settings"			
Mode	Output mode		47
Logic funct.	Logic function mode		47
Source: channel 1	Channel 1 alarmstate source		47
Source: channel 2	Channel 2 alarm state source		47
Source: channel 3	Channel 3 alarm state source		47
Source: channel 4	Channel 4 alarm state source		47
Source: channel 5	Channel 5 alarm-state source		47
Source: channel 6	Channel 6 alarm-state source		47

Parameter	Description	Value	Description page
Source: channel 7	Channel 7 alarm-state source		47
Source: channel 8	Channel 8 alarm-state source		47
Close delay	Close switch delay time		47
Open delay	Open switch delay time		47
Closed hold time	Time for holding the closed state		48
Open hold time	Time for holding the open state		48
Output 2 settings in submenu "Outputs settings"			
Mode	Output mode		47
Logic funct.	Logic function mode		47
Source: channel 1	Channel 1 alarm state source		47
Source: channel 2	Channel 2 alarm state source		47
Source: channel 3	Channel 3 alarm state source		47
Source: channel 4	Channel 4 alarm state source		47
Source: channel 5	Channel 5 alarm state source		47
Source: channel 6	Channel 6 alarm state source		47
Source: channel 7	Channel 7 alarm state source		47
Source: channel 8	Channel 8 alarm state source		47
Close delay	Close switch delay time		47
Open delay	Open switch delay time		47
Closed hold time	Time for holding the closed state		48
Open hold time	Time for holding the open state		48
Parameters in the "RS485 port settings" menu			
Address	Device address		48
Baud rate	Baud rate		49
Resp. delay	Delay of device response		49
Conf. change	Permission for modifying unit's parameters through RS-485 interface		49
Language	User interface language		50

II. USER MANUAL FOR “S-TOOLKIT”

System requirements:

At least i486 computer,
Colour monitor with minimum resolution of 640 x 480,
1 MB of free hard drive space.
Designed for Windows
tested on Windows® XP, Windows® Vista, Windows® 7, Windows® 8

1. GENERAL CHARACTERISTICS

The **S-Toolkit** software enables configuration reading and writing operations, updating the device firmware and obtaining basic information about devices through RS-485 serial interface. This application enables to quickly and easily define device parameters in one of three possible configuration models. The set of parameters can be transmitted directly to the device or stored in a file for future use.

2. INSTALLATION AND STARTUP

The **S-Toolkit-install** file is designed to install the program. The install file is located in **S-Toolkit** folder on CD delivered with device. During installation follow the directions provided by **Installation wizard**. The wizard will create a folder called **S-Toolkit** on the computer's hard drive, program files will be placed in this folder. The shortcut to the program will be placed in a location specified by the user.

Manual startup of the program is done using the **SToolkit.exe** executable file. Directly after startup the program will attempt to establish communication with the device in order to read the current setup. The attempt to establish communications is executed using default (during initial program startup) settings of RS-485 port options (baud rate 9600 b/s, address 0, port: COM2) or setting defined by the user during previous launch of the program. If these settings are different than the default, or those recently used, the program will signal the communications error. After setting correct values in the **Interface options** tab, read the current configuration in **RS485 port settings** section using the **[Read from device]** button.

3. USING PROGRAM

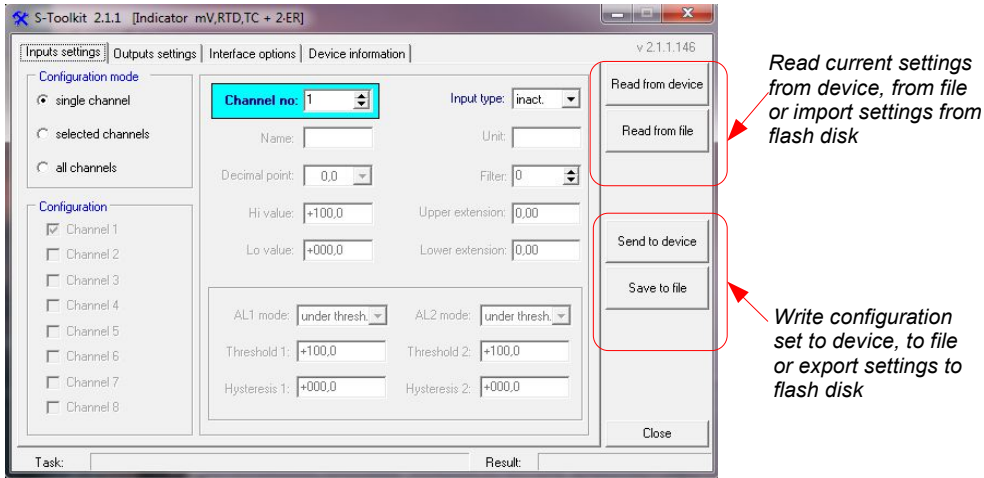

Fig. 3.1. Program main window

There are four tabs in the central part of program window:

- **Inputs settings** - this tab enables group and individual configuration of all channels of the device;
- **Outputs settings** - this tab allows to configure device outputs;
- **Interface options** - this tab allows user to set RS-485 interface-related parameters, changing LCD display parameters, software and firmware language selection, and synchronizing the unit time and date with computer's time and date;
- **Device information** - this tab allows obtaining basic information about the unit and update the unit's firmware.

In the right part of the window there are five buttons:

- **[Read from device]** - reads current configuration from the device;
- **[Read from file]** - reads the configuration saved previously to a file on computer's hard drive;
- **[Send to device]** - saves the settings shown in the **Inputs settings** tab and writes the configuration set to the device;
- **[Save to file]** - saves the settings shown in the **Inputs settings** tab and writes the configuration set to a file on computer's hard drive;
- **[Close]** - exits the program.

Status information concerning currently performed operation is shown in the bottom of the window.

3.1. "INPUTS SETTINGS" TAB

Channel configuration method selection

Defining individual parameters of selected channels

Selecting configured channels

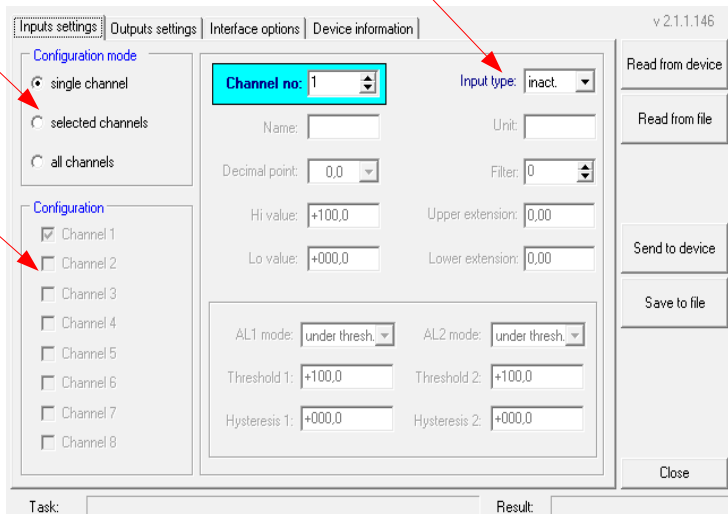

Fig. 3.2. Inputs settings tab options

There are two sections in this tab:

- Configuration mode** - select the channel configuration method in this tab. If the **"single channel"** option will be selected it will be possible to set configuration parameters for only one from the channels available in the device. **"all channels"** options enables setting configuration parameters for all channels at the same time; **"selected channels"** option enables setting configuration parameters for a number of selected channels at the same time.
- Configuration** - this section defines, which channels are currently configured. If **"single channel"** or **"all channels"** option was checked in the **"configuration mode"** section, then selection of channels is made automatically. If **"selected channels"** option was checked in the **"configuration mode"** section, then the user can define which channels of the device he intends to configure at the moment.

For detailed description of available device configuration methods see **CONFIGURATION MODES** section.

In the central part of the tab (in a separated panel) there are fields for configuring device parameters. The parameters can be configured in three modes. Detailed description of individual parameters can be found in the user manual for device.



- The "°" (degree) sign can be entered by pressing the "°" key on the keyboard.
- The content of the list, depends on the type of device being configured.

3.2. "OUTPUTS SETTINGS" TAB

This tab contains options for configuring device outputs. Detailed description of individual parameters can be found in the user manual for device.

Fig. 3.3. **Outputs settings** tab options

3.3. "INTERFACE OPTIONS" TAB

This tab contains three sections:

- **RS485 port settings** - in this section define the address of configured device, transmission speed for the serial interface and the number of the serial port, to which the configured device is connected. In order for communication between the program and the device to be possible, the address and baud rate set in the program must be same as the ones set in the device.
- **Display options** - this section allows changing parameters of LCD display of configured device.

- **Language** - in this section user can select the language of **S-Toolkit** software and device firmware.

There are two buttons in the lower part of the tab:

- **[Lock write to device]** - lock the possibility of writing configuration registries of the device through the RS-485 interface;



Unlocking the possibility of writing configuration registries through the RS-485 serial interface is only available from the device menu (manual configuration of device).

- **[Synchronize date and time]** - synchronizes date and time of configured device with computer's time and date.

Defining parameters for communicating with device

LCD parameters setting

Language selection

Locking the possibility of writing device registers

Synchronizing device time and date with computer's time and date

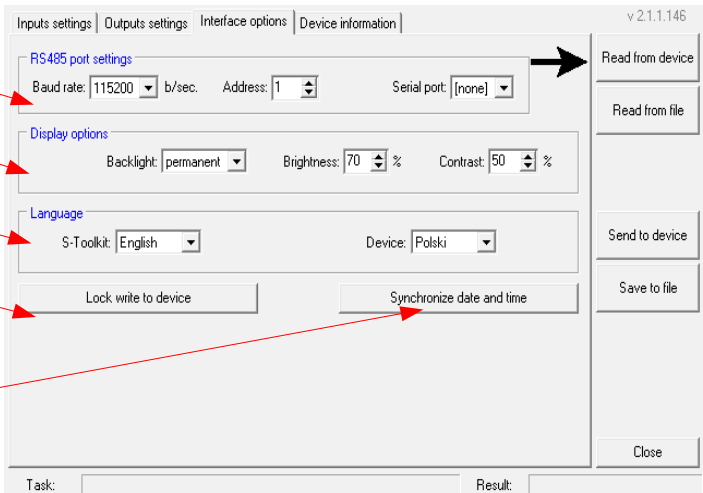

Fig. 3.4. Interface options tab functions



If device clock shows later time than computer's system clock, then the synchronization (in this case reversing device clock) will cause all data recorded by device after the time set during synchronization to be deleted. Download the data to the computer **prior to synchronization** in order not to lose it.

Detailed description of individual parameters can be found in the user manual for device.

3.4. “DEVICE INFORMATION” TAB

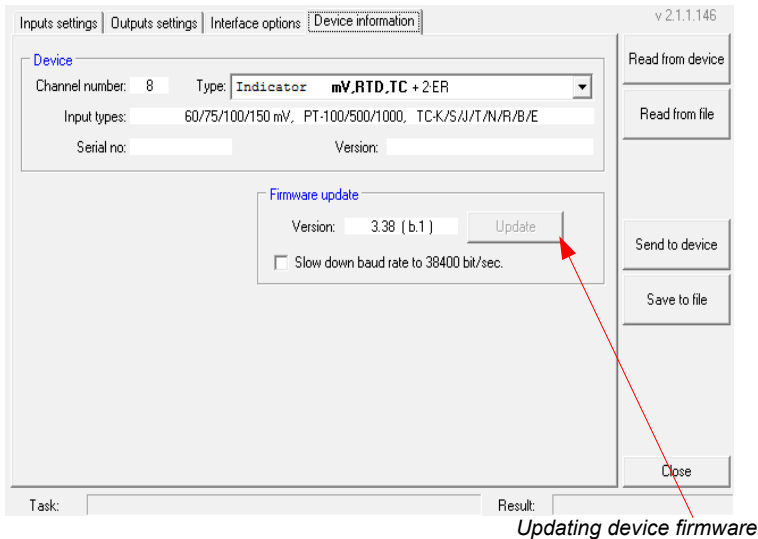

Fig. 3.5. Device information tab options

This tab has three sections:

- **Device** - this section displays information concerning the device type and current version of device firmware.
- **Firmware update** - this section allows updating the device software,

Detailed description of update can be found in “**UPDATING DEVICE FIRMWARE**” section.



Informations in **Device** and **Memory** sections are being updated while reading, writing or synchronizing date and time of the unit.

3.5. CONFIGURATION MODES

Depending on the option selected in **Configuration mode** section of **Inputs settings** tab three methods of configuring the device are available.



The content of the list, depends on the type of device being configured (see: description „**DEVICE INFORMATION**”)

3.5.1. Individual configuration of channels

In single channel configuration mode it is possible to change and view parameters individually for each channel. If the parameters for a given channel will be modified, then the change of number of configured channel, channel configuration method or active program tab, will result in displaying a message asking to save the settings for the recently configured channel. Confirming the save does not result in sending them to the device, it only saves the parameters shown in the **Inputs settings** tab to computer memory. If the **[Send to device]** or **[Save to file]** button is pressed after changing the parameters the program will automatically save the changed parameters without asking the user for confirmation.

3.5.2. Configuring selected channels

After switching to selected channels configuration mode, the parameters' values of most recently configured channel remain in the configuration fields. If the parameters for selected channels will be modified, then the change of channel configuration method or active program tab will result in displaying a message asking to save the settings for channels selected in the **Configuration** section (if no channel is selected the message will not be displayed). Confirming to save the parameters does not result in sending them to the device, it only saves the parameters shown in the **Inputs settings** tab to computer memory.



Settings for selected channels will be saved only after changing the configuration mode, when writing the settings to file or during transmitting the settings to device. Therefore perform one of the aforesaid operations prior to configuring the next group of selected channels. Due to the time of writing the configuration to device it is recommended to write the set configuration to file.

3.5.3. Configuring all channels

After switching to all-channels configuration mode, the values for most recently configured channel remain in the configuration fields. Switching to the single channel configuration mode or selected channels configuration mode will result in displaying a message asking to save the settings for all channels. Confirming the save parameters does not result in sending them to the device it only saves the parameters shown in the **Inputs settings** tab to computer memory.

3.6. UPDATING DEVICE FIRMWARE

The **Firmware update** section in the **Device information** tab enables device software update. To update the software: press the **[Update]** button. During update process the application attempts to reset the unit. If the device will not reset within a few seconds, the device must be reset manually by disconnecting and reconnecting power supply. Default baud rate during device software update is 115200 bps. If transmission with this baud rate is not possible, check the Slow **down baud rate to 38400 bit/sec.**



Firmware update is possible (the **[Update]** button is active) if the updating software version is newer than the device software. In exceptional cases (update interrupted or unit does not operate after update) contact the manufacturer.

The newest version of device firmware is available at producer homepage.

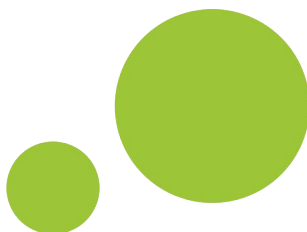

**SIMEX Sp. z o.o.
ul. Wielopole 11
80-556 Gdańsk
Poland**

**tel.: (+48 58) 762-07-77
fax: (+48 58) 762-07-70**

**<http://www.simex.pl>
e-mail: info@simex.pl**